

**2.2.1 THE**  
**CONSTRUCTION**  
**INDUSTRY**  
**CIVIL DRAWINGS**  
**(Floor plan)**

Developed by: PC Viljoen  
Senior Educational Specialist for  
Engineering Graphics and Design  
Free State Province

# PRESCRIBED CONTENT FOR GRADE 10, 11 & 12

- **The floor plan showing the windows and doors.**
- Elevation drawings.
- Sectional elevations showing the detail from the foundation to the roof ceiling.

# FLOOR PLAN

- The walls of a house can be
  - load bearing (220mm)
  - or
  - non-load bearing (110mm)

# FLOOR PLAN

- The walls of a house

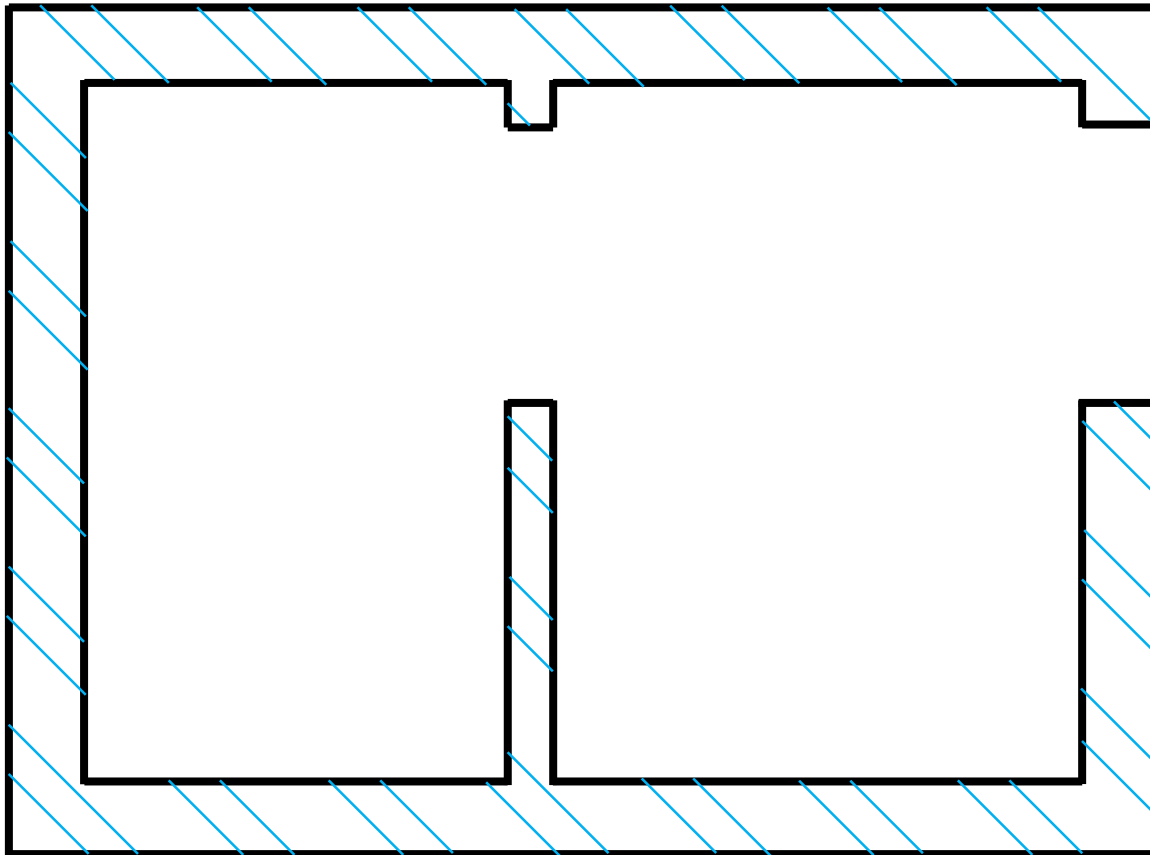

# FLOOR PLAN

- The walls of the house

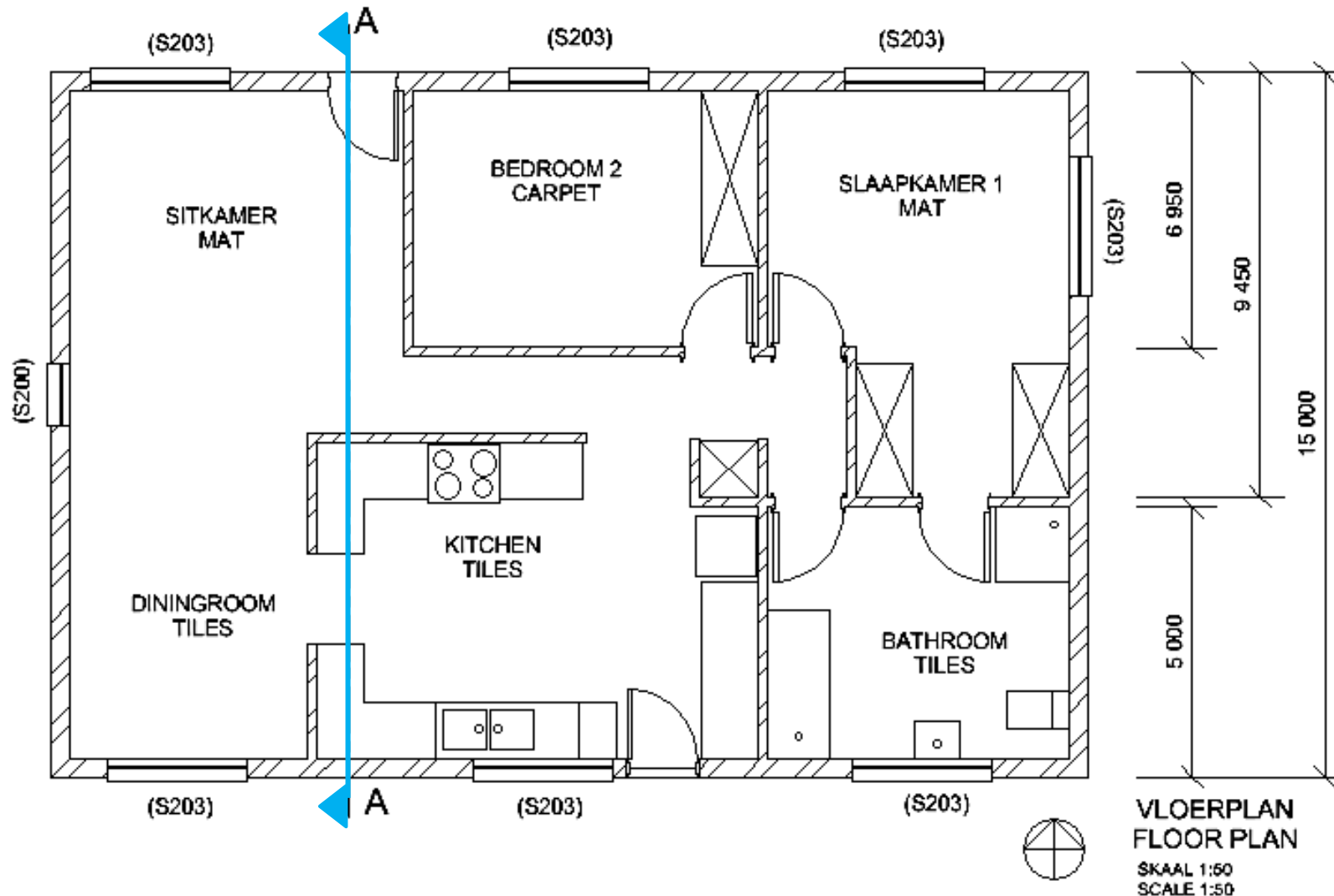

# FLOOR PLAN

- Interior & exterior door openings.

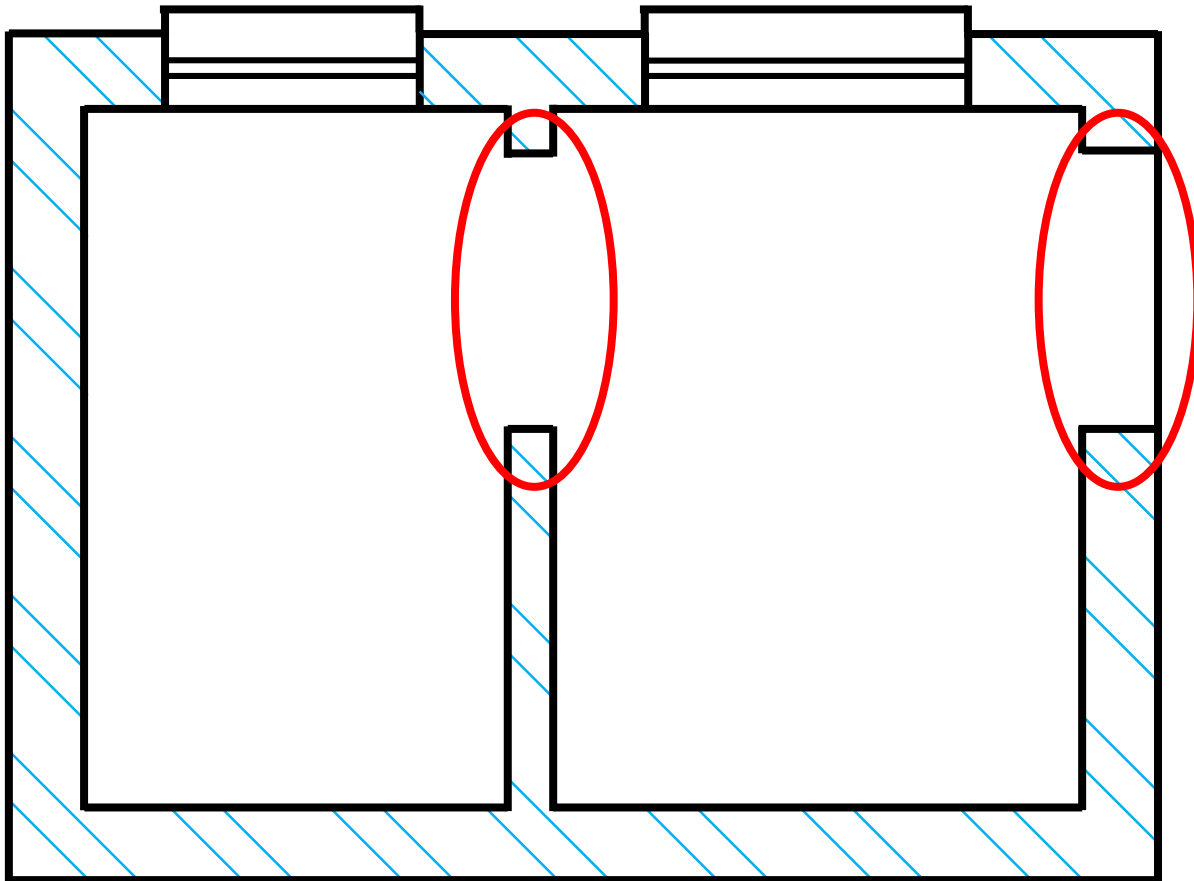

# FLOOR PLAN

- Exterior garage door openings.

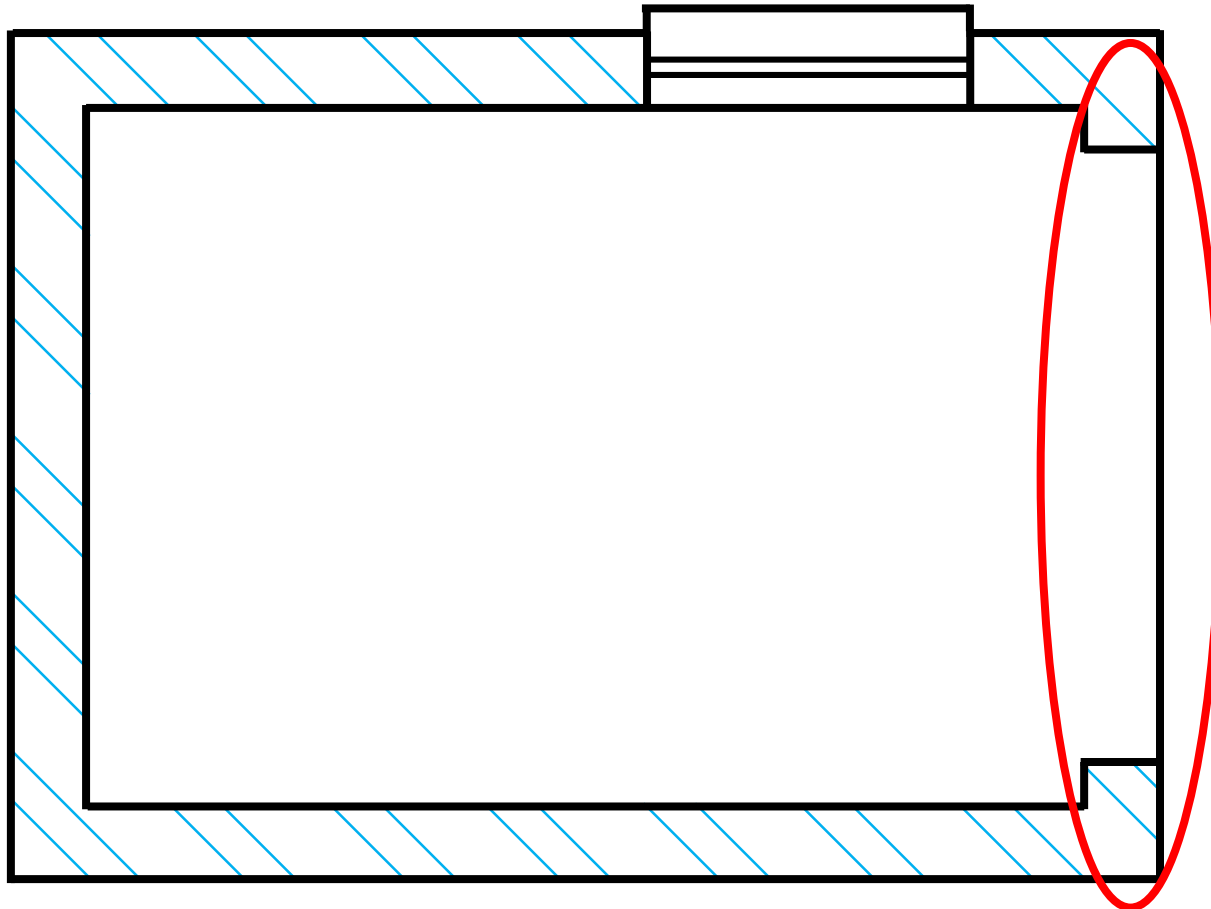

# FLOOR PLAN

- The doors of a house

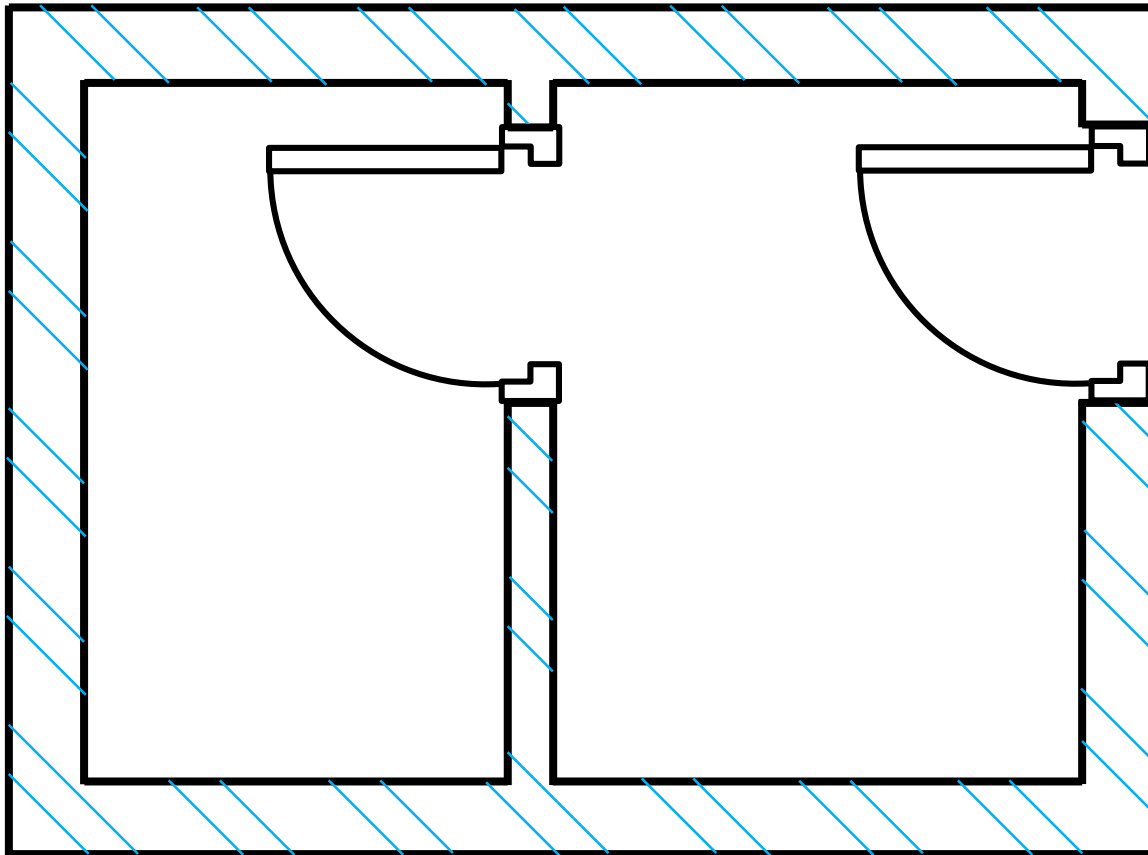



# FLOOR PLAN

- The door frames of a house can be manufactured from...
  - Wood
  - Steel or
  - Aluminum

# FLOOR PLAN

- Wooden door frame

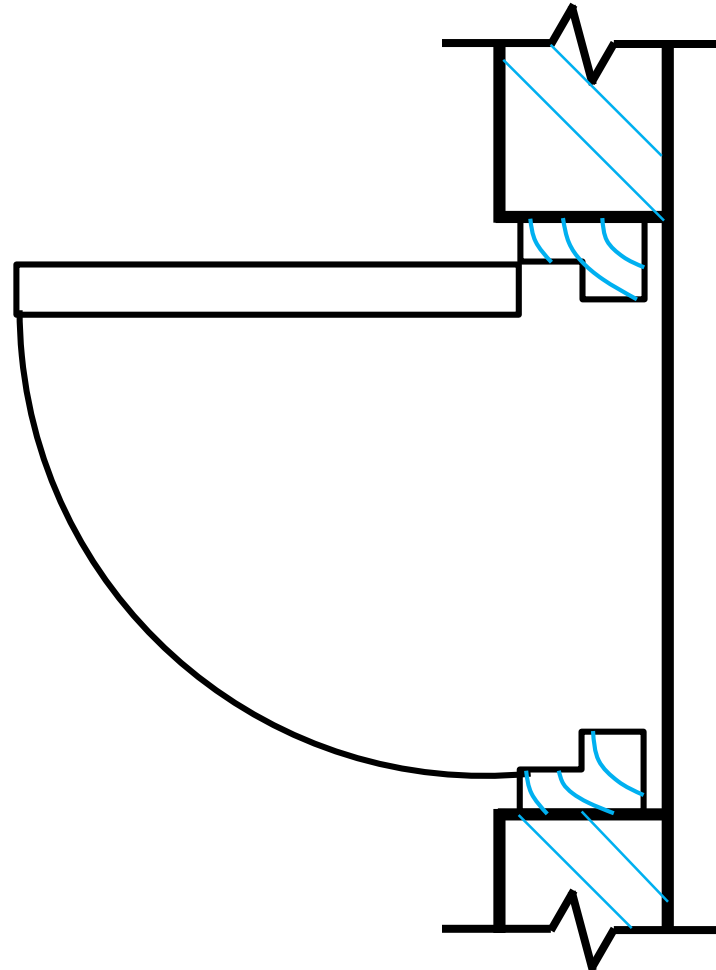

# FLOOR PLAN

- Steel door frame

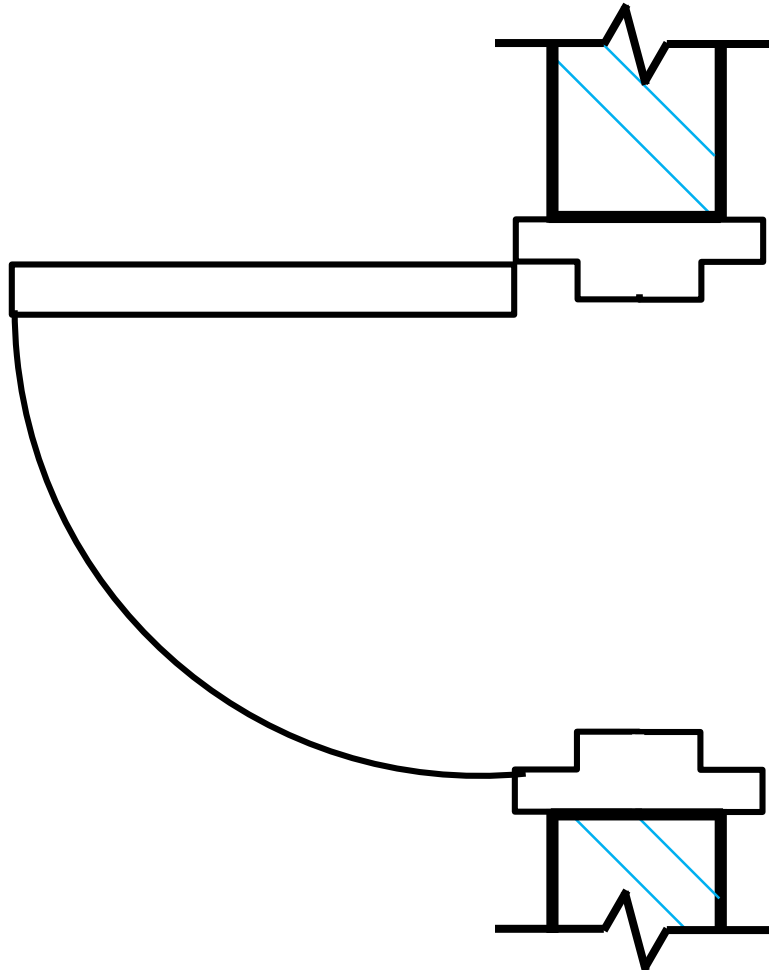

# FLOOR PLAN

- Aluminum door frame
  - The arrow indicate the sliding direction of the door.

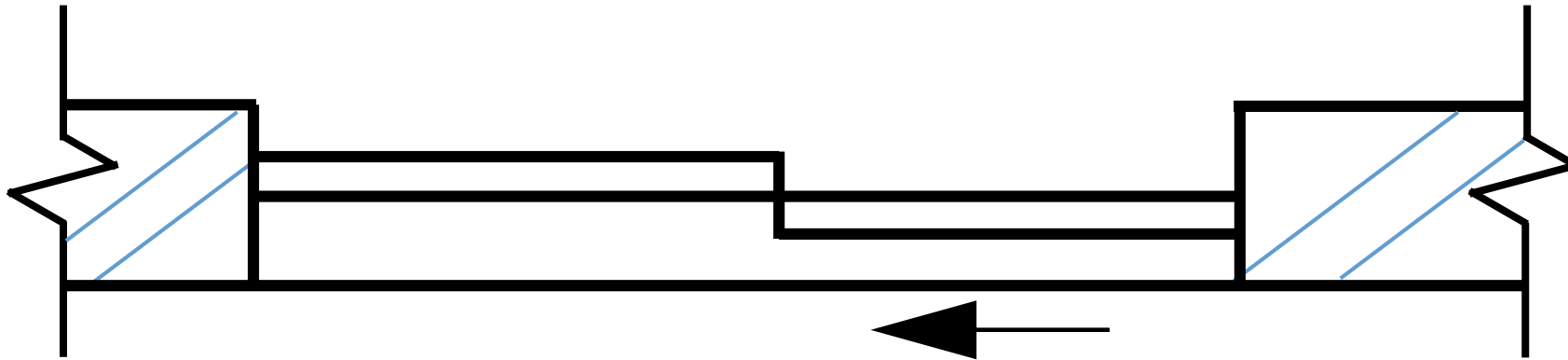

# FLOOR PLAN

- All door openings (functionality & privacy)

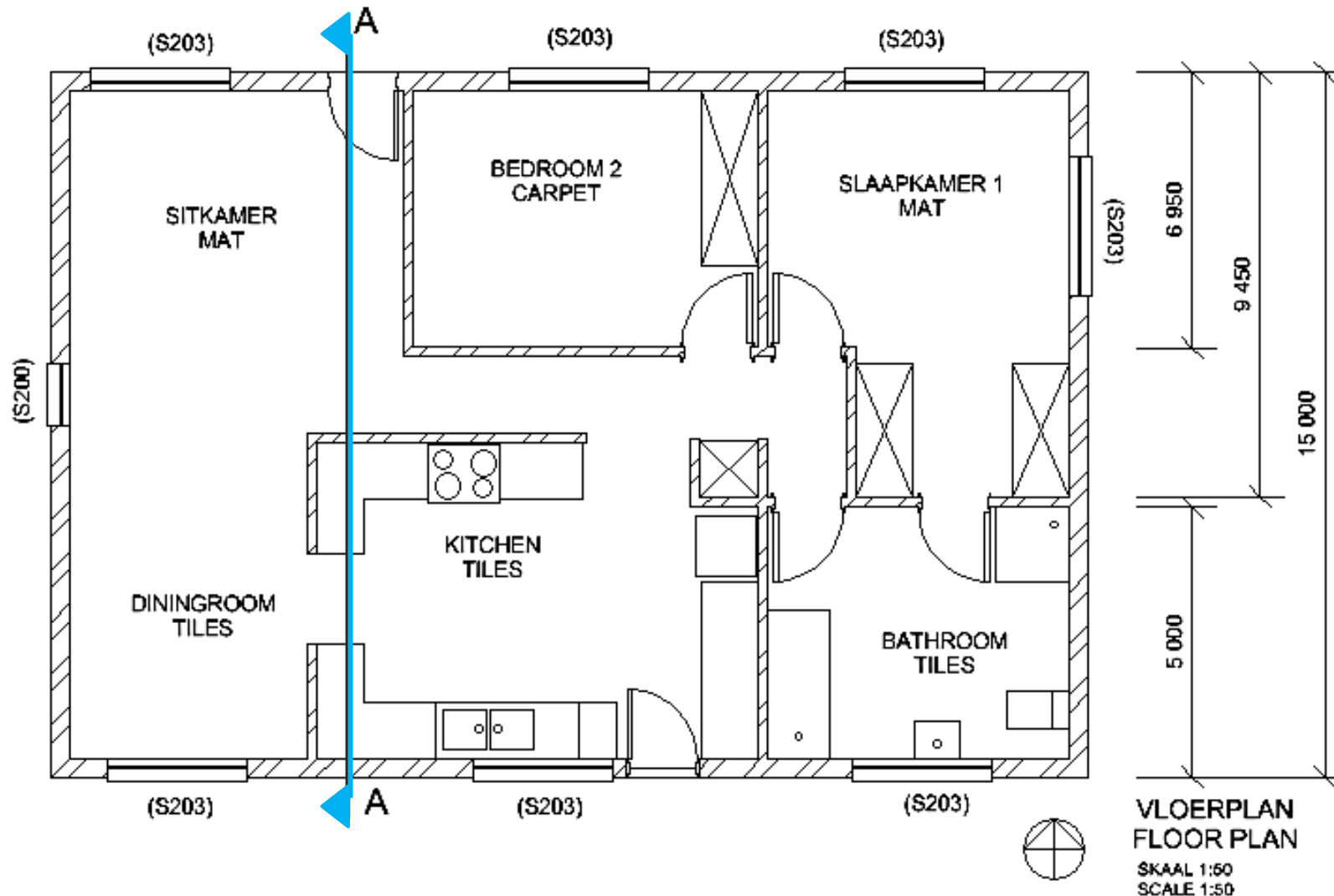

# WINDOWS ARE AVAILABLE IN DIFFERENT SHAPES & SIZES

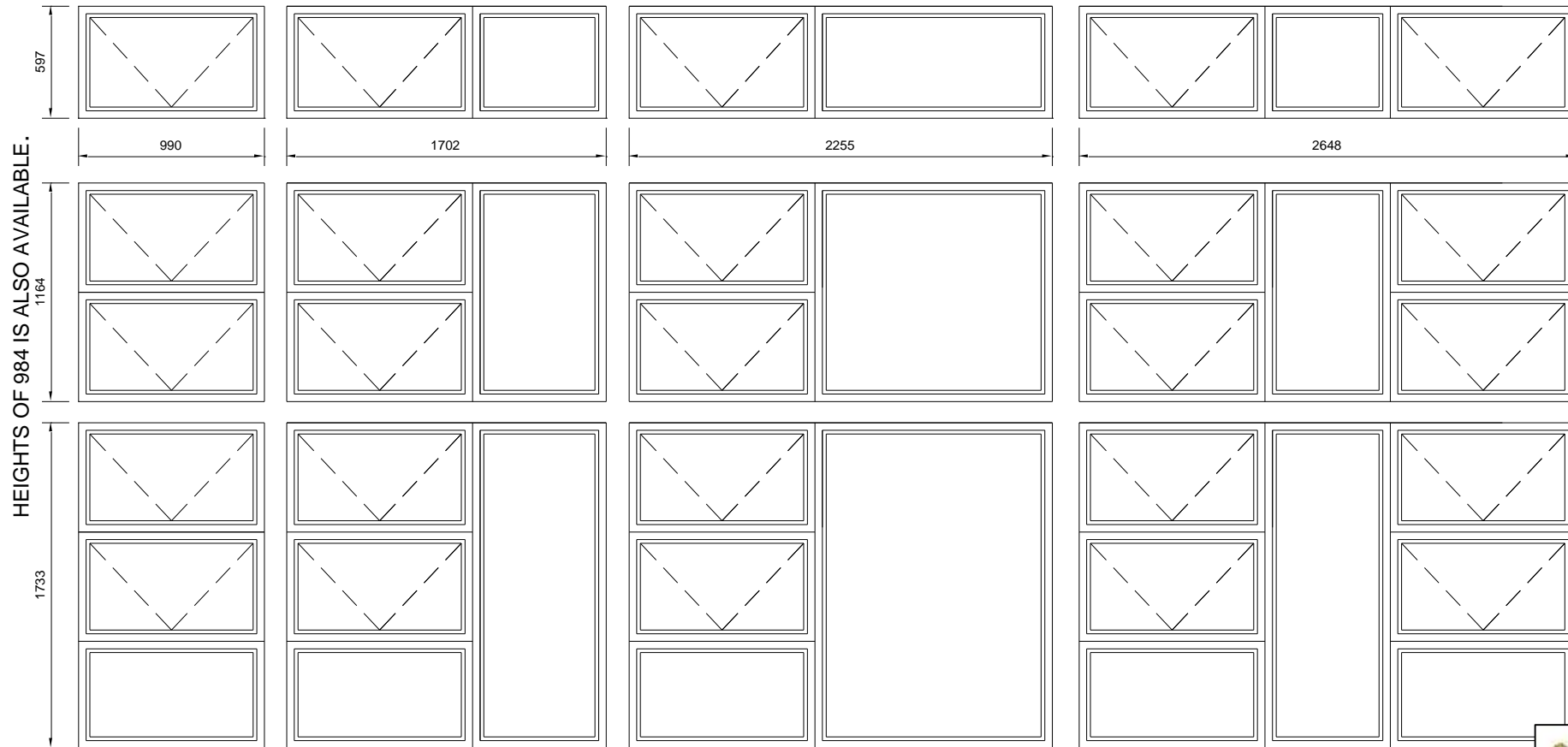

WIDTHS OF 3200 IS ALSO AVAILABLE.

# WINDOWS ARE AVAILABLE IN DIFFERENT SHAPES & SIZES

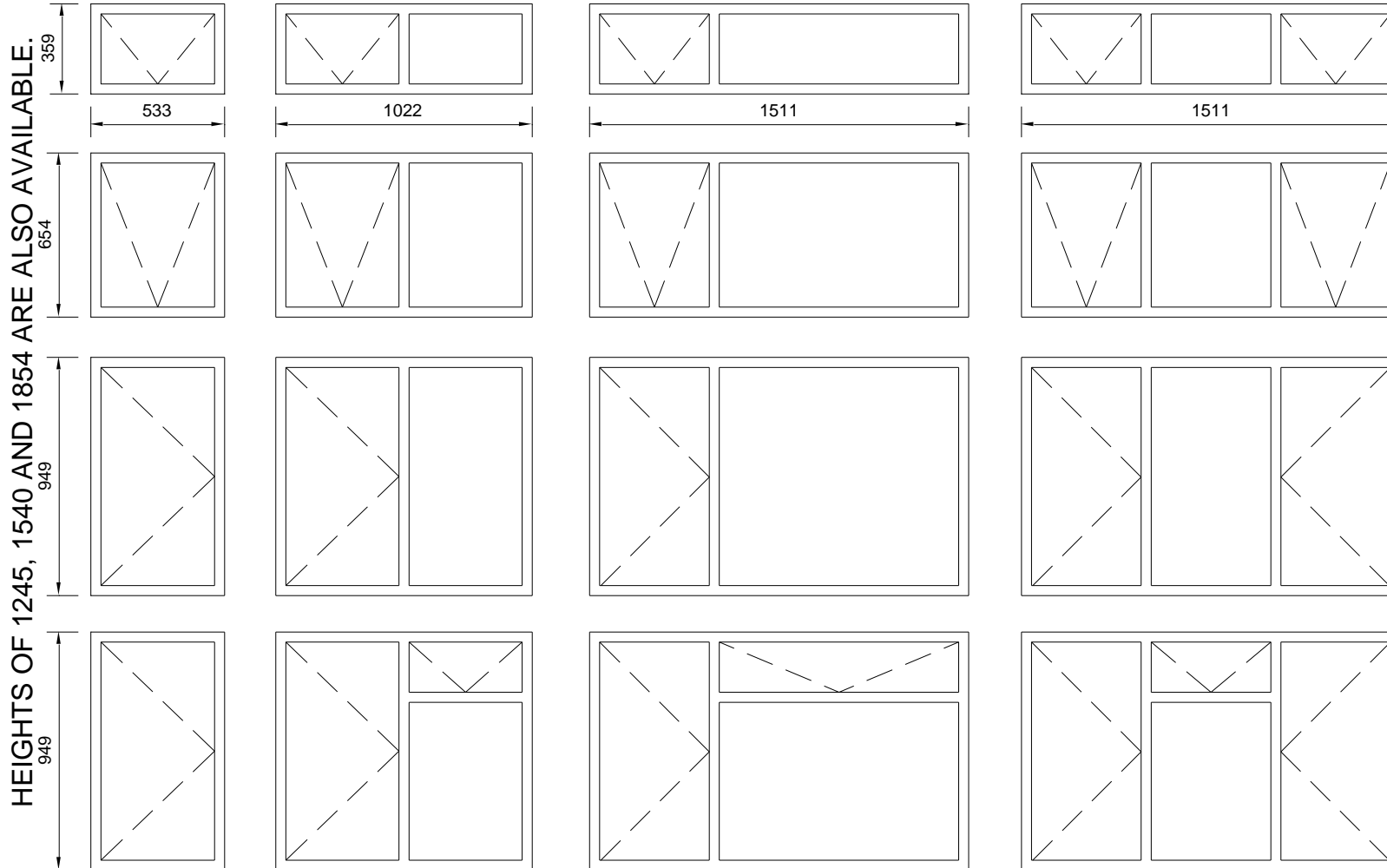

WIDTHS OF 305, 2000 AND 2489 ARE ALSO AVAILABLE.

# FLOOR PLAN

- Drawing a window with a window sill

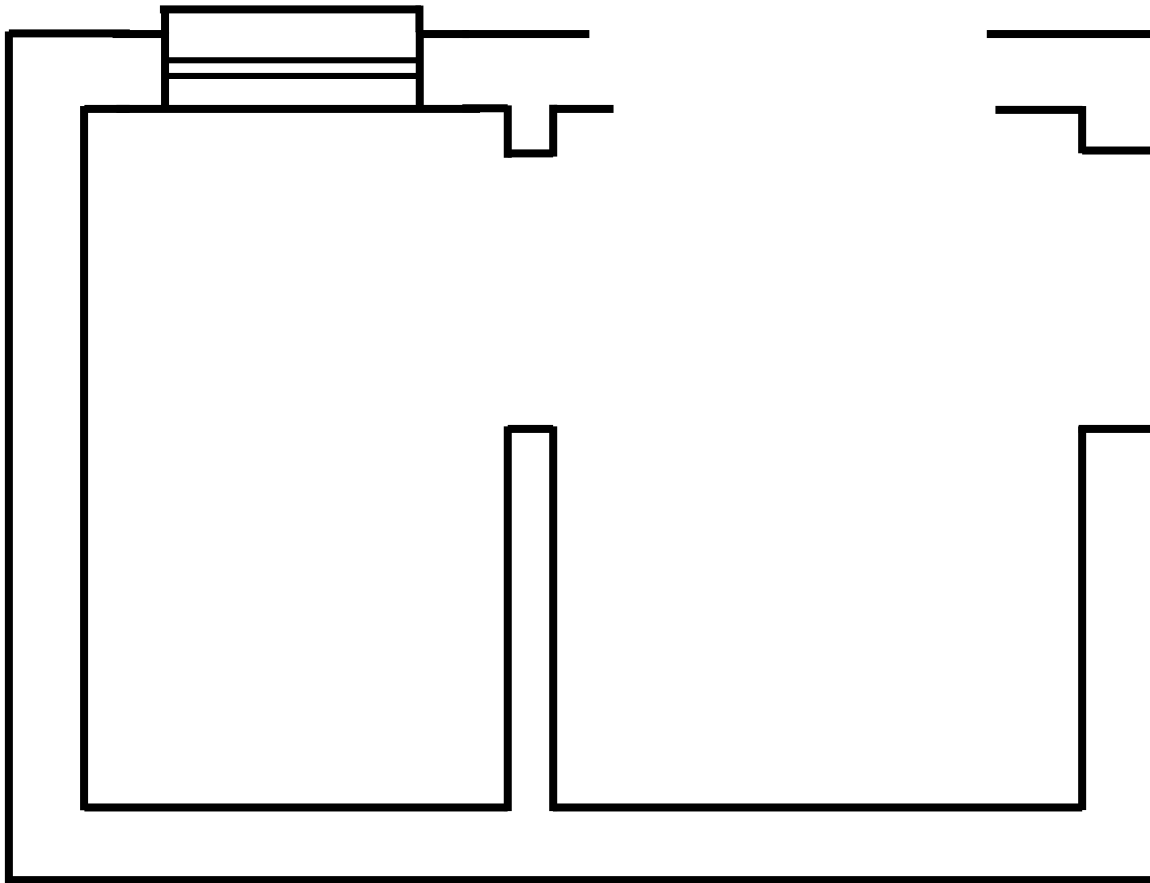



# FLOOR PLAN

- The window placement on exam scripts

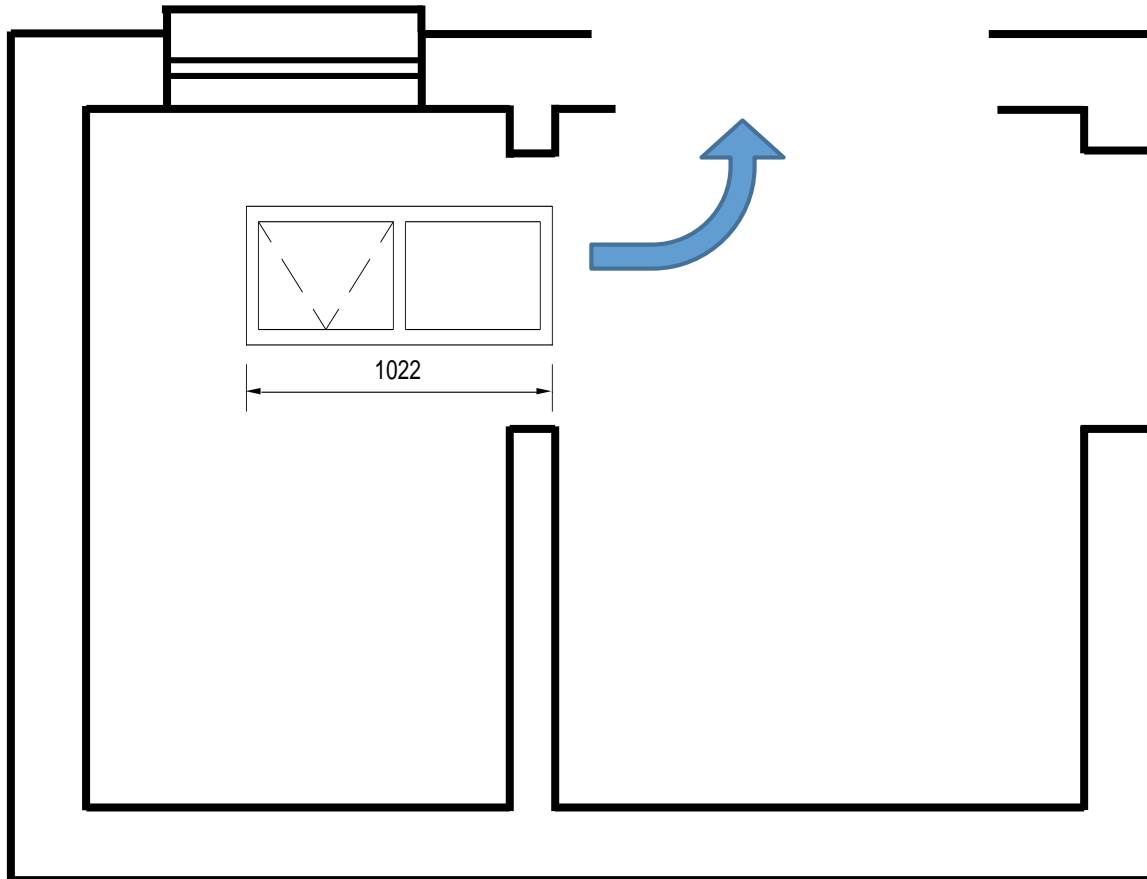

On an exam question paper, the gaps for window placement will be given larger than the size of the window.

# FLOOR PLAN

- The window placement on exam scripts

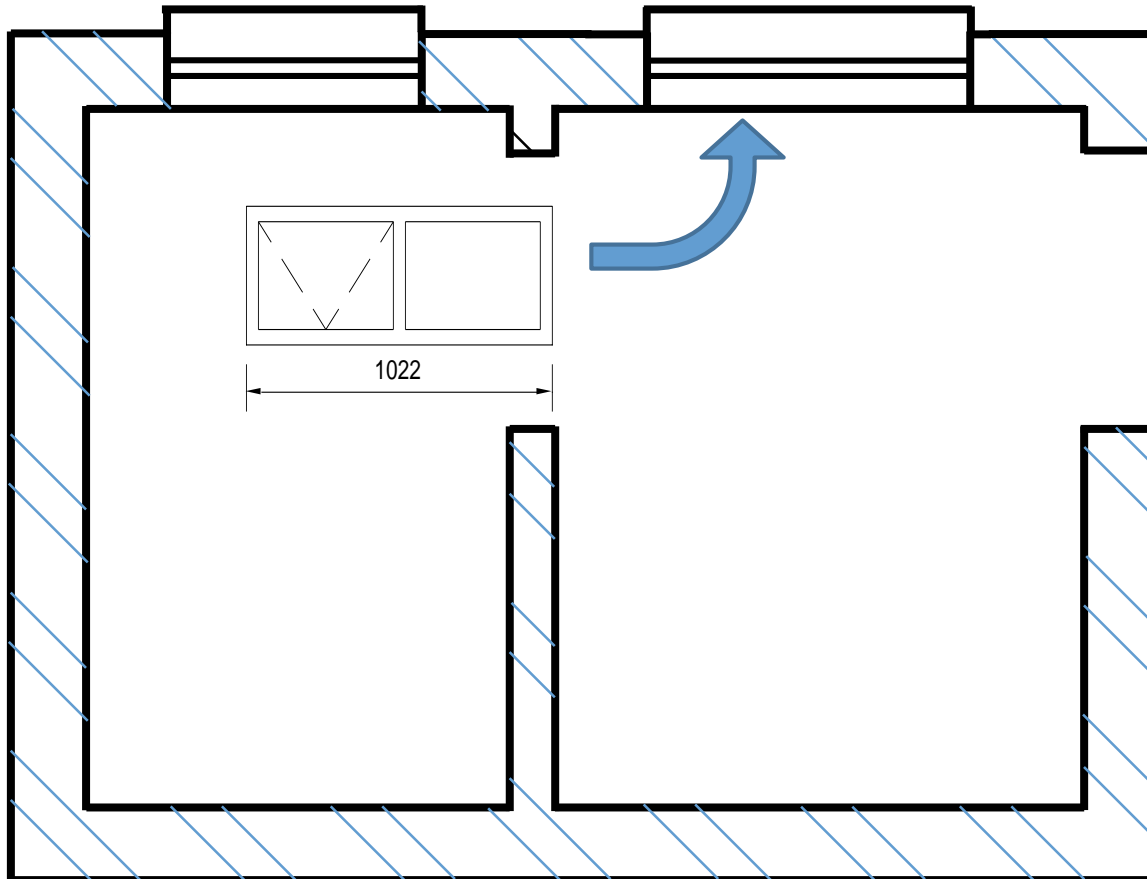

Always size the window according to scale before fit.

# FLOOR PLAN

- Label all windows according to window codes

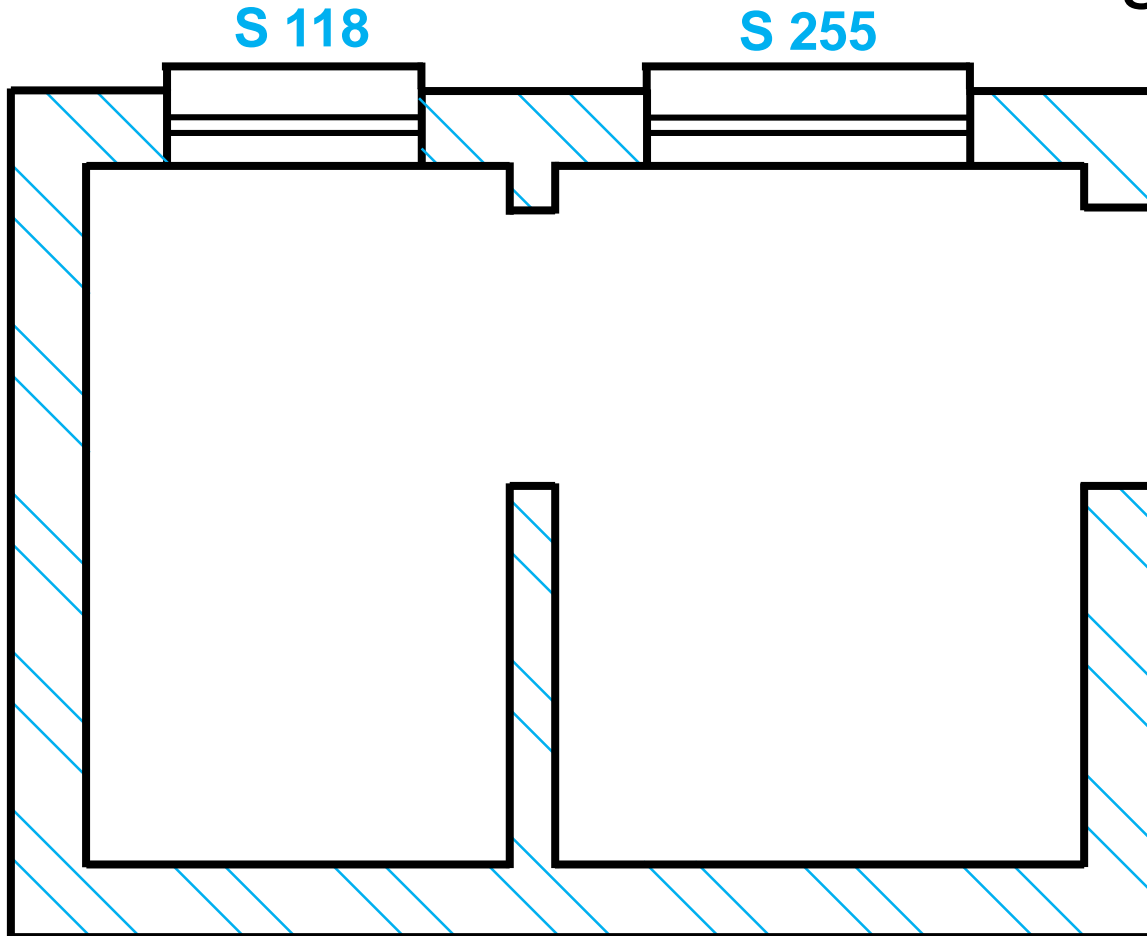

# FLOOR PLAN

- The windows of a house

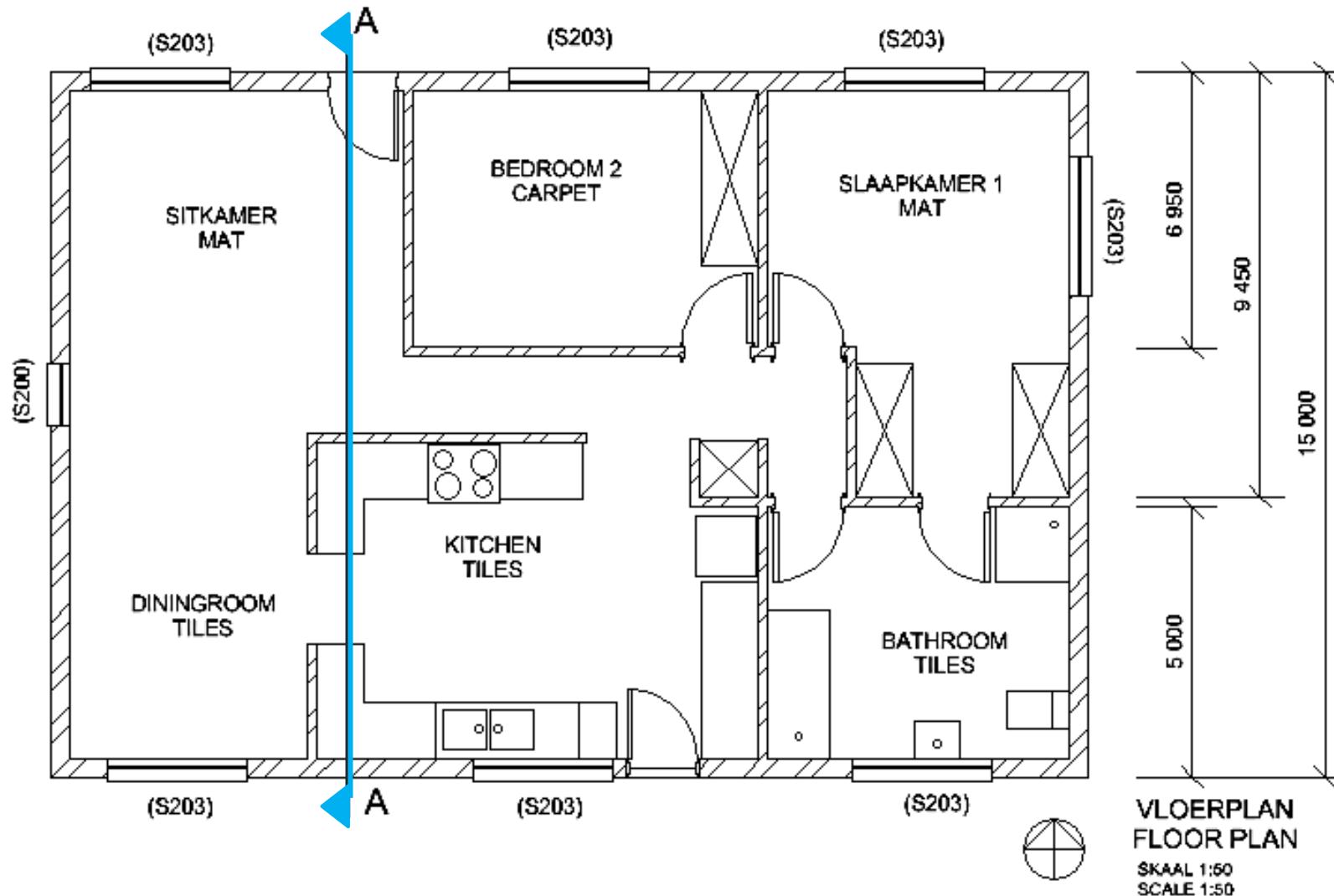

# FLOOR PLAN

- Label room designations & floor coverage

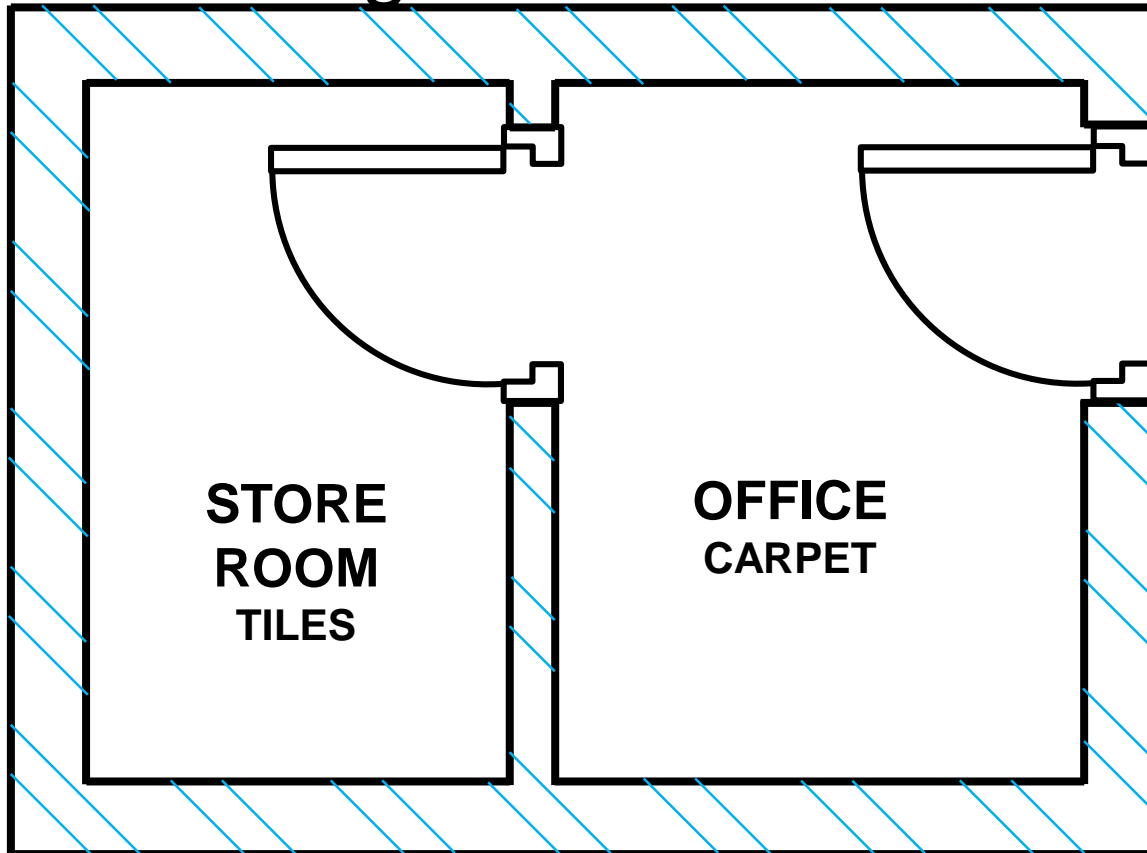

# FLOOR PLAN

- Label room designations & floor coverage

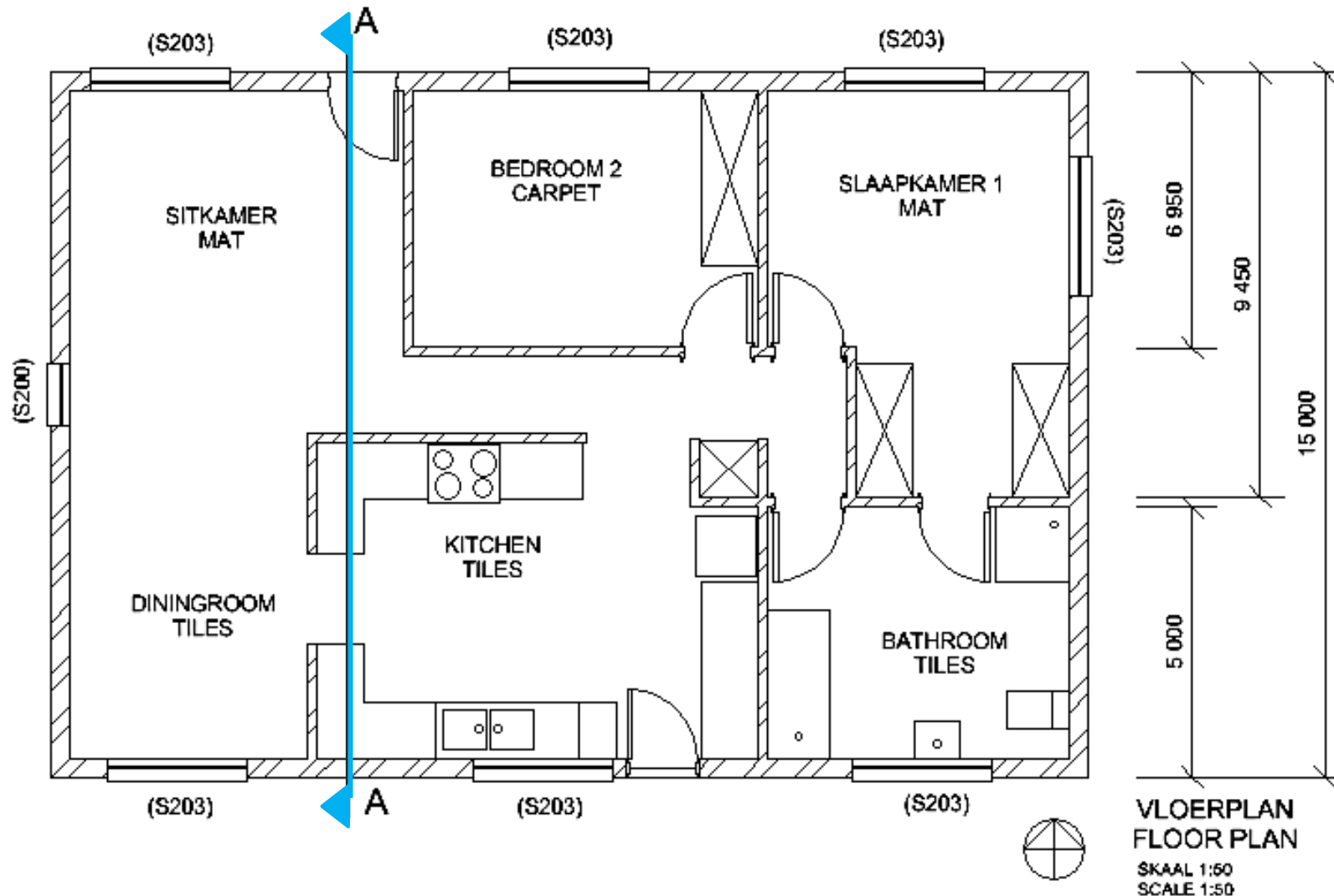

# FLOOR PLAN

## ■ Dimensions

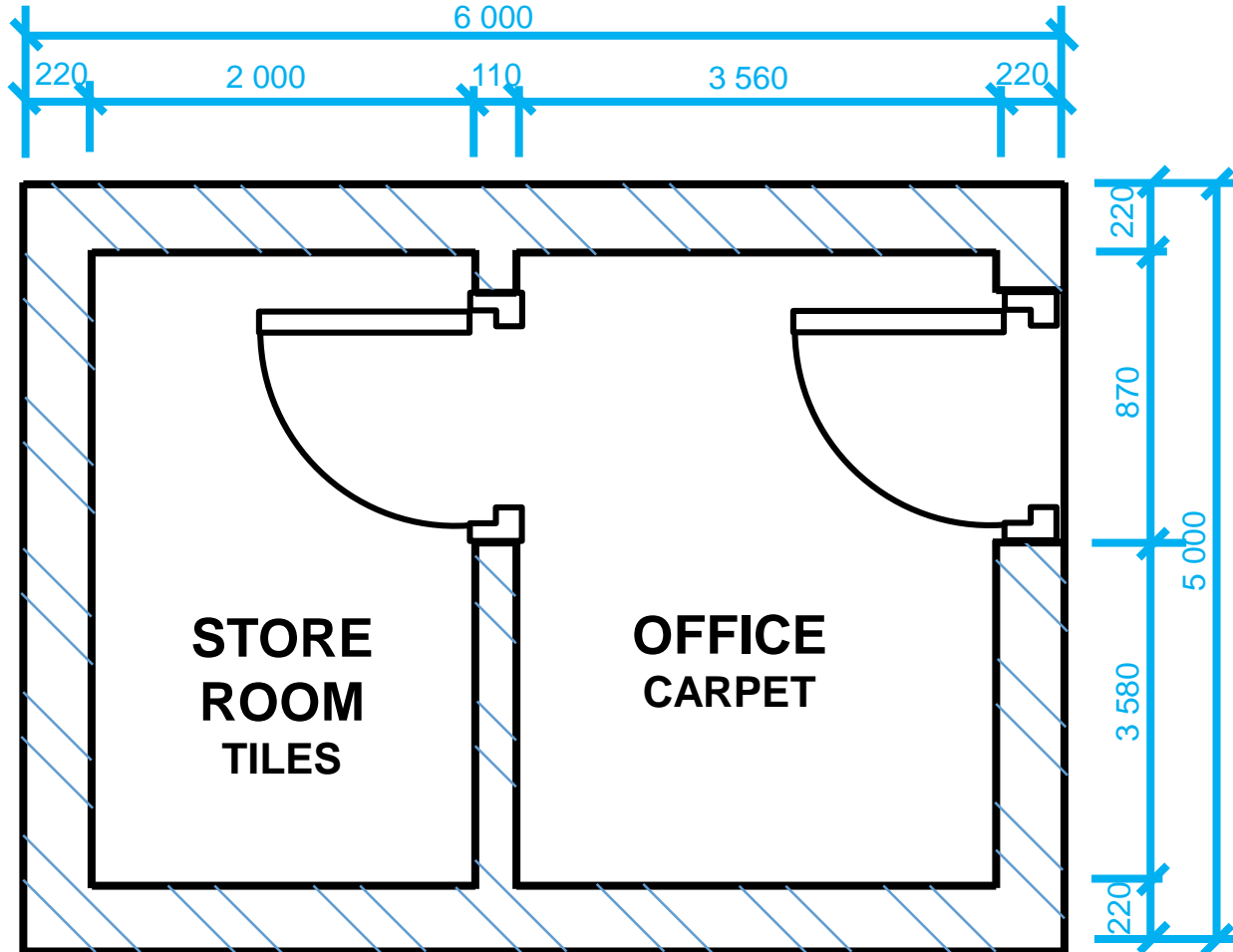

# FLOOR PLAN

- The roof line

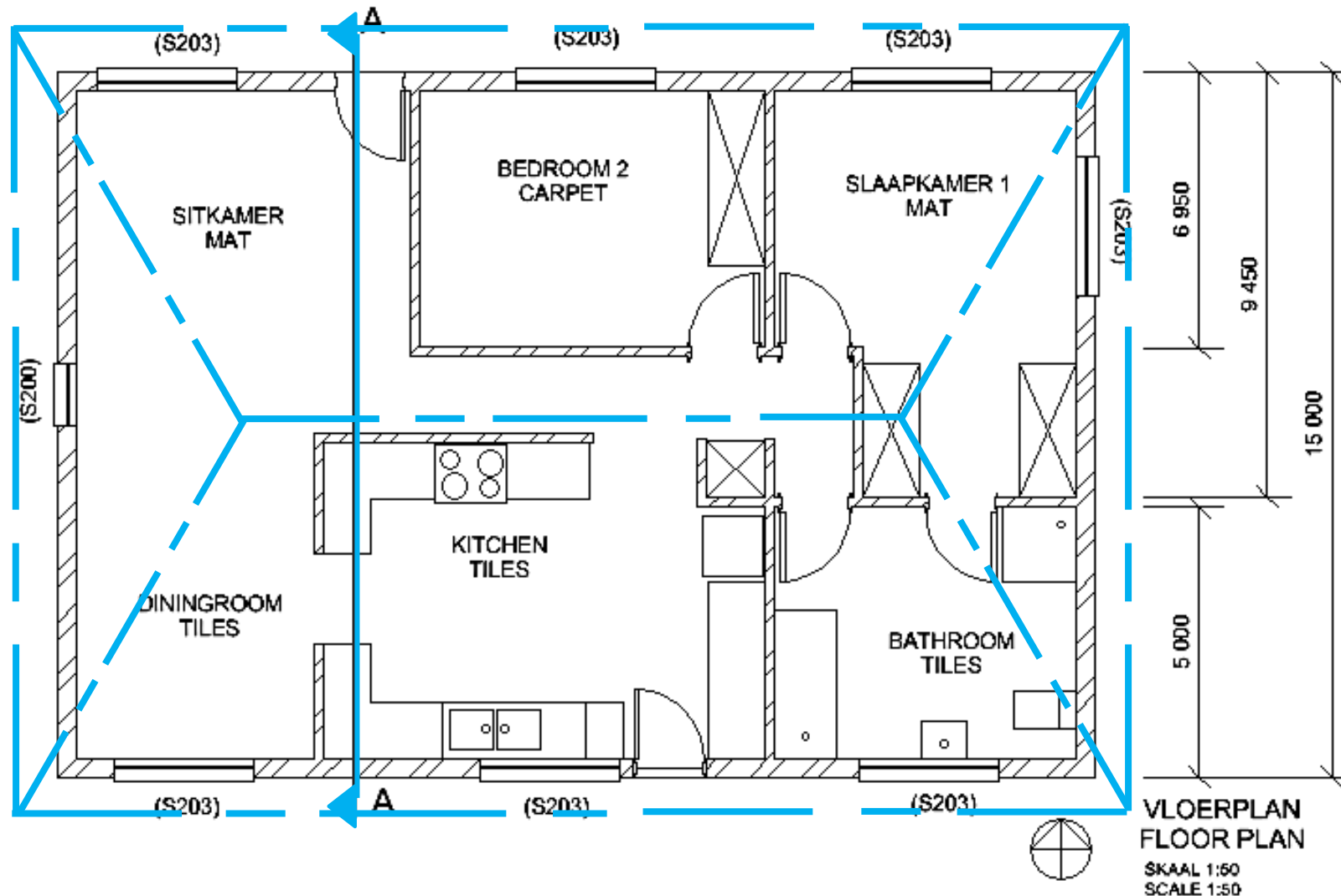



# FLOOR PLAN

- The scale of the drawing

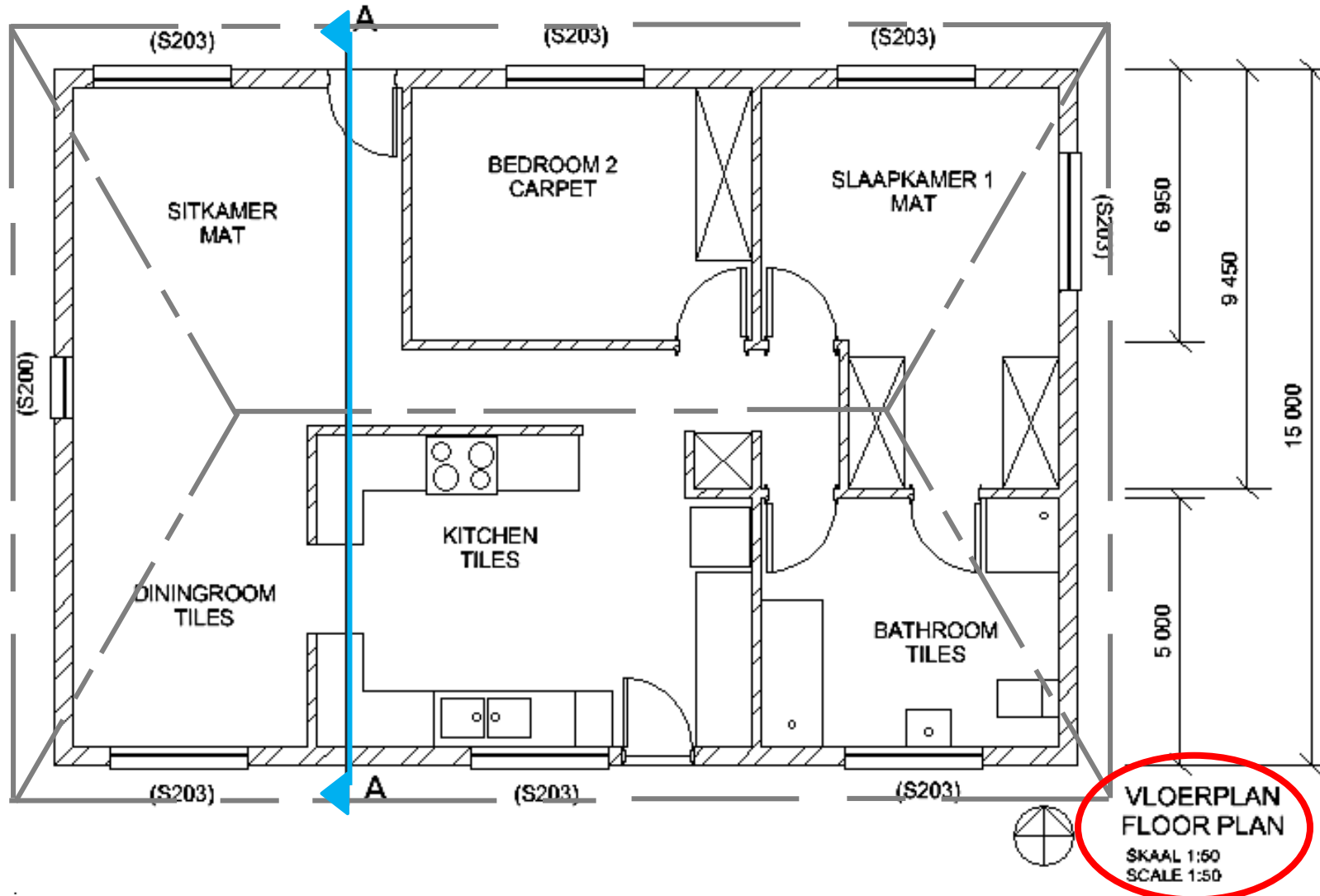

# FLOOR PLAN

- The North arrow of the drawing

