



# ISOMETRIC DRAWINGS

## Drawing Principles

Developed by: PC Viljoen  
Senior Educational Specialist for  
Engineering Graphics and Design  
Free State Province



education

Department of  
Education  
FREE STATE PROVINCE

# ISOMETRIC DRAWINGS

- **Question:** Use the given orthographic views and convert it into an isometric drawing.

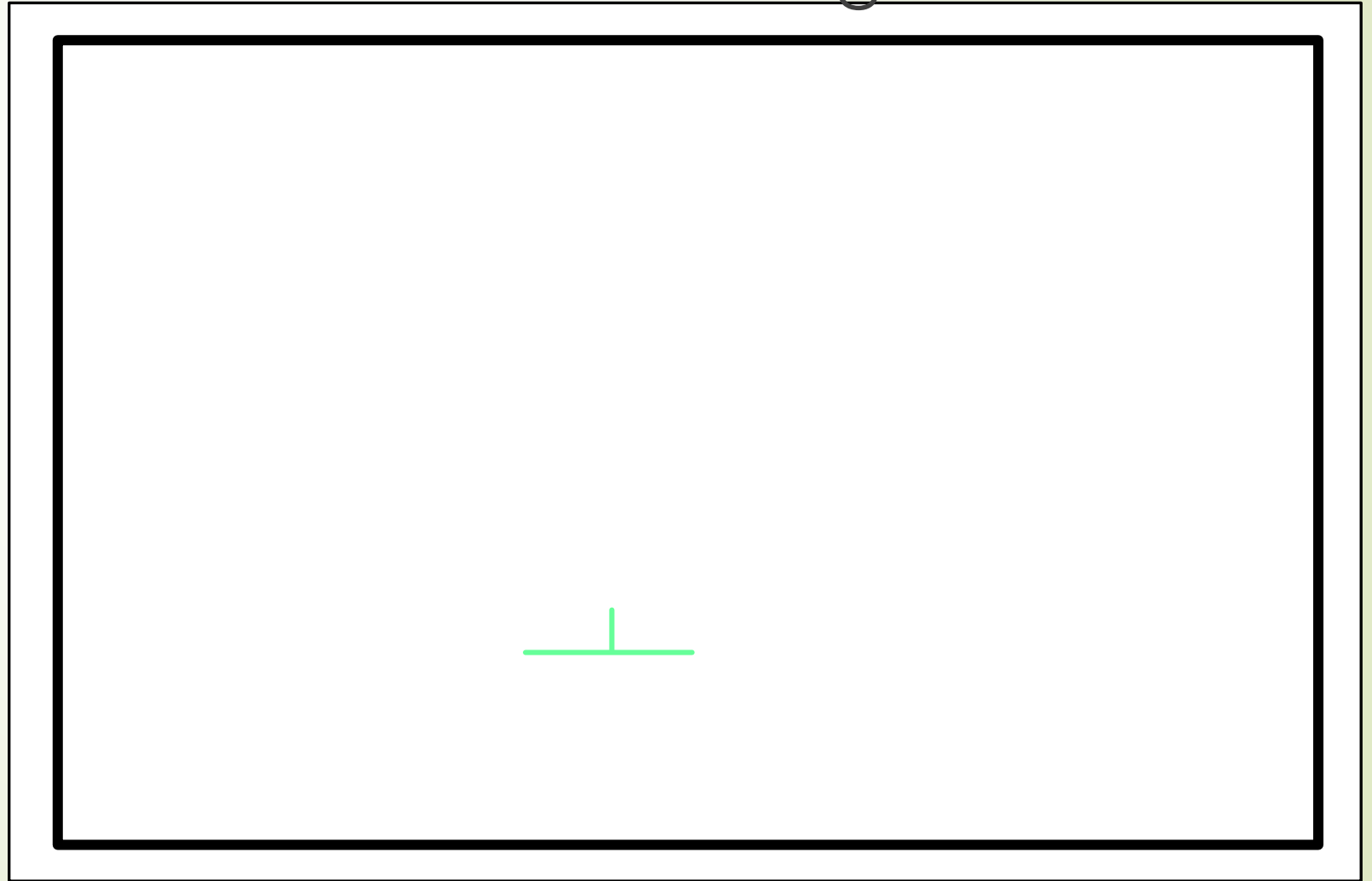
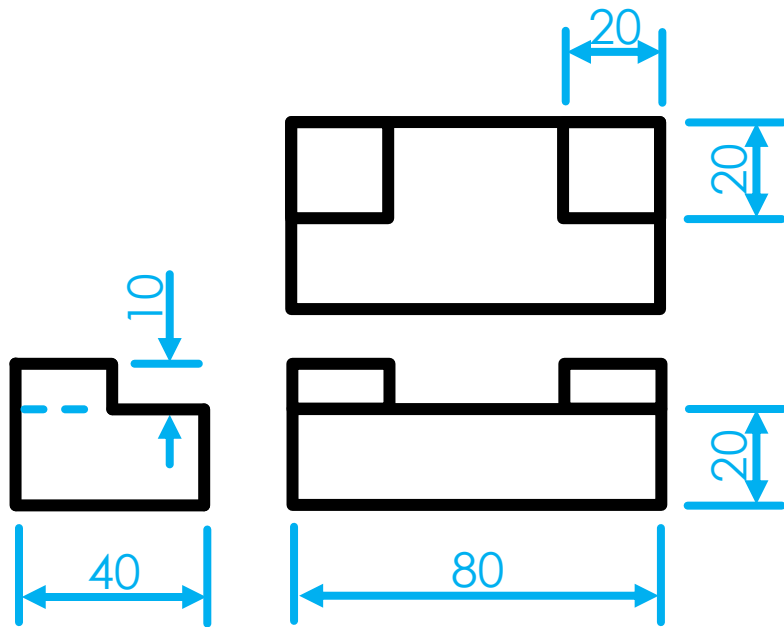

# ISOMETRIC DRAWINGS

- **Question:** Use the given orthographic views and convert it into an isometric drawing.

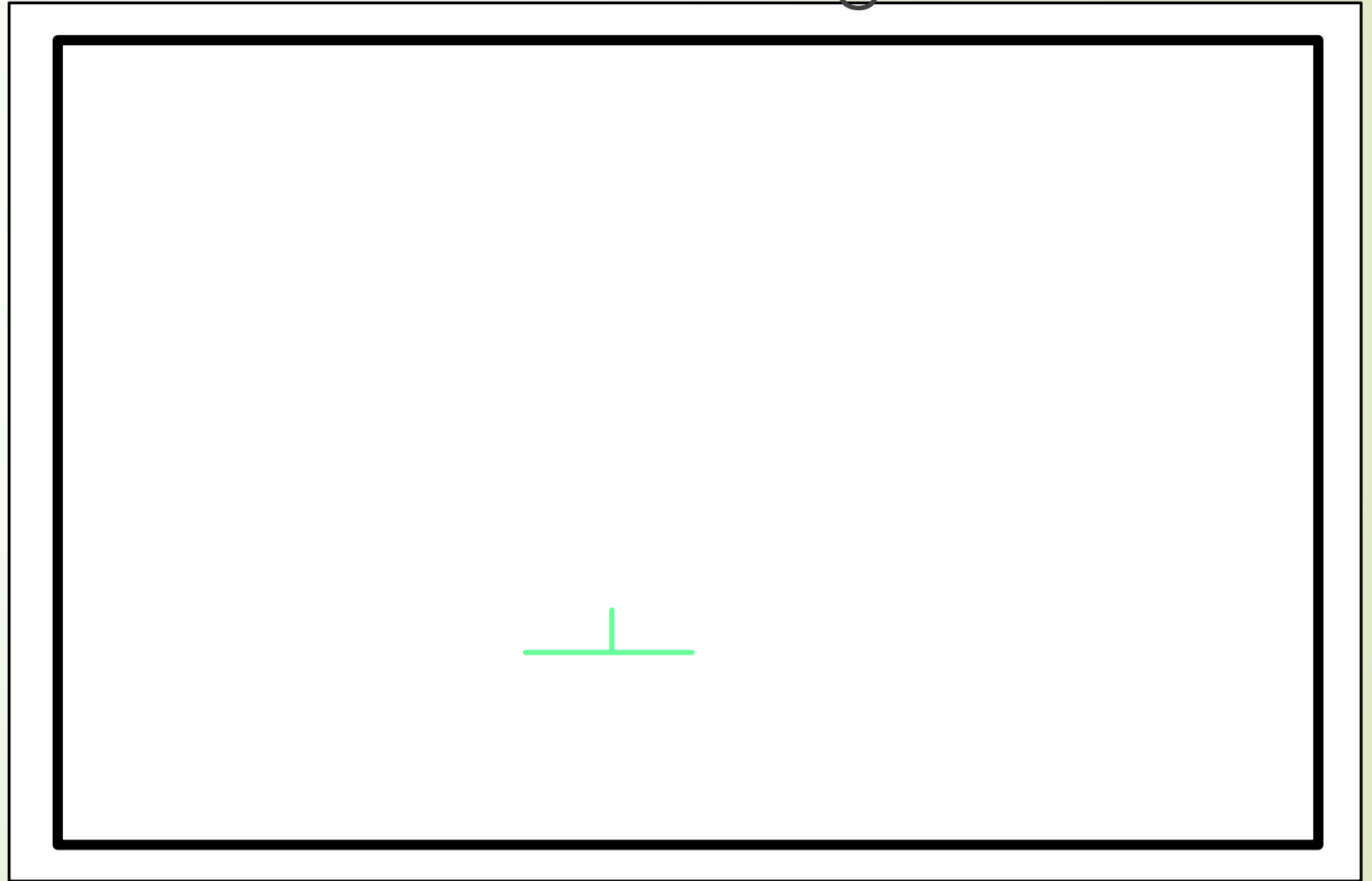
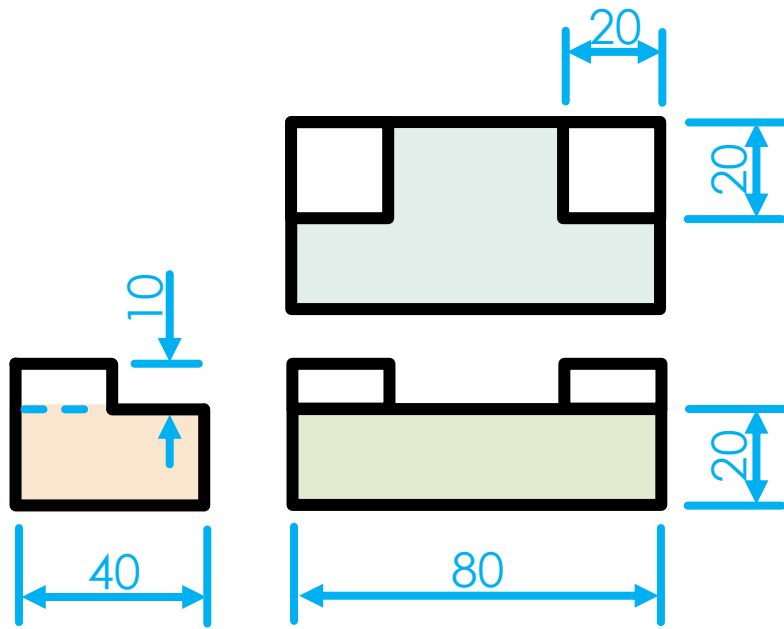

# ISOMETRIC DRAWINGS

- **Question:** Use the given orthographic views and convert it into an isometric drawing.

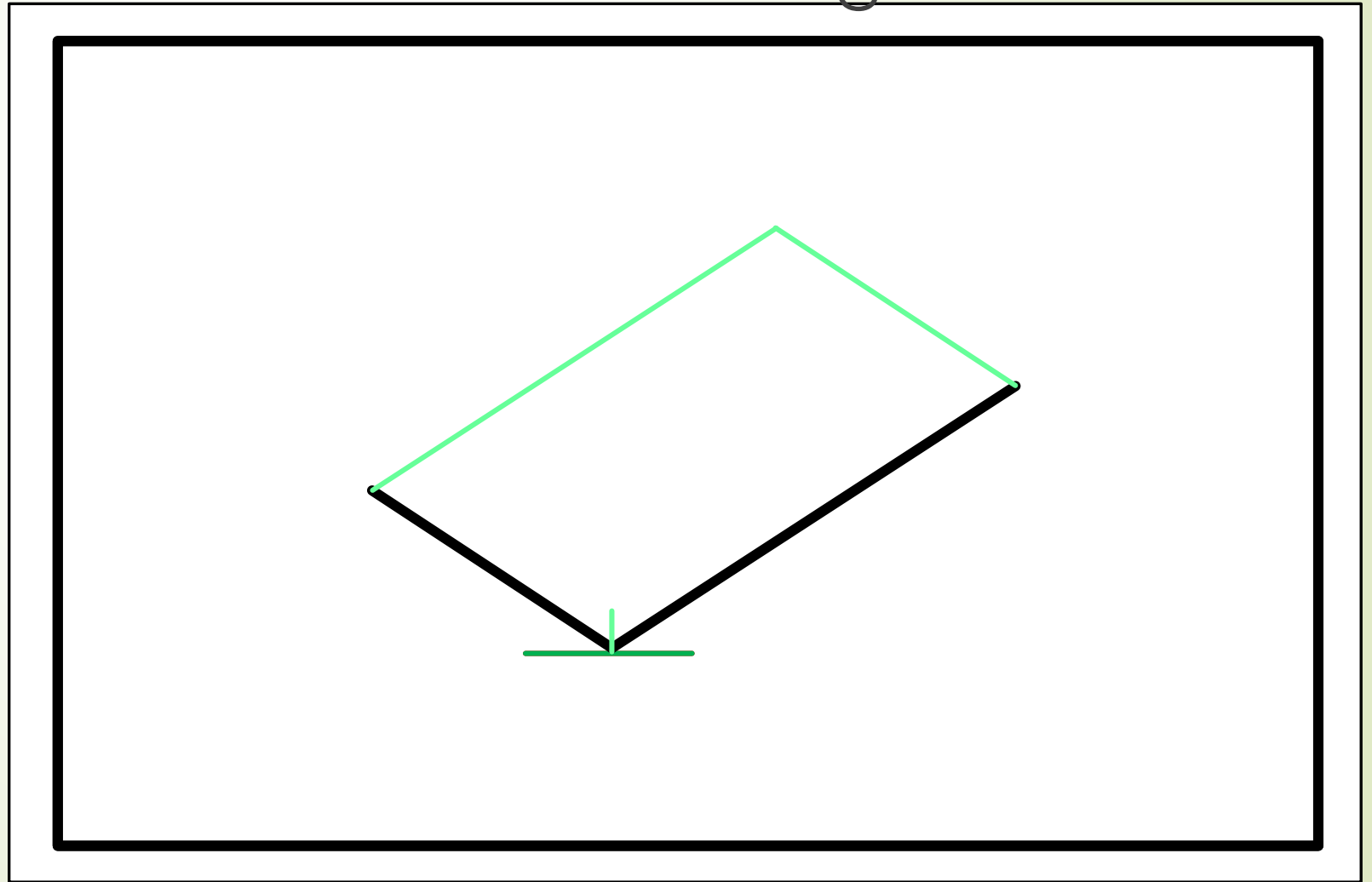
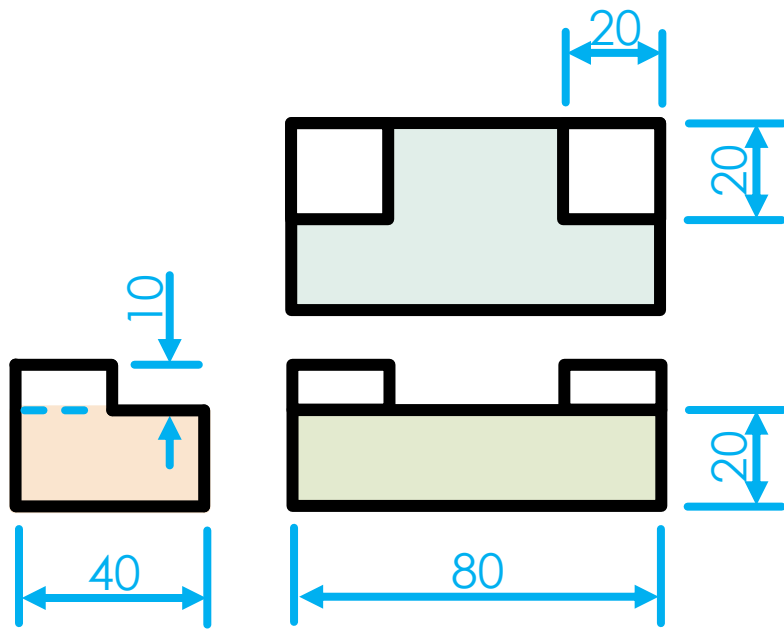

# ISOMETRIC DRAWINGS

- **Question:** Use the given orthographic views and convert it into an isometric drawing.

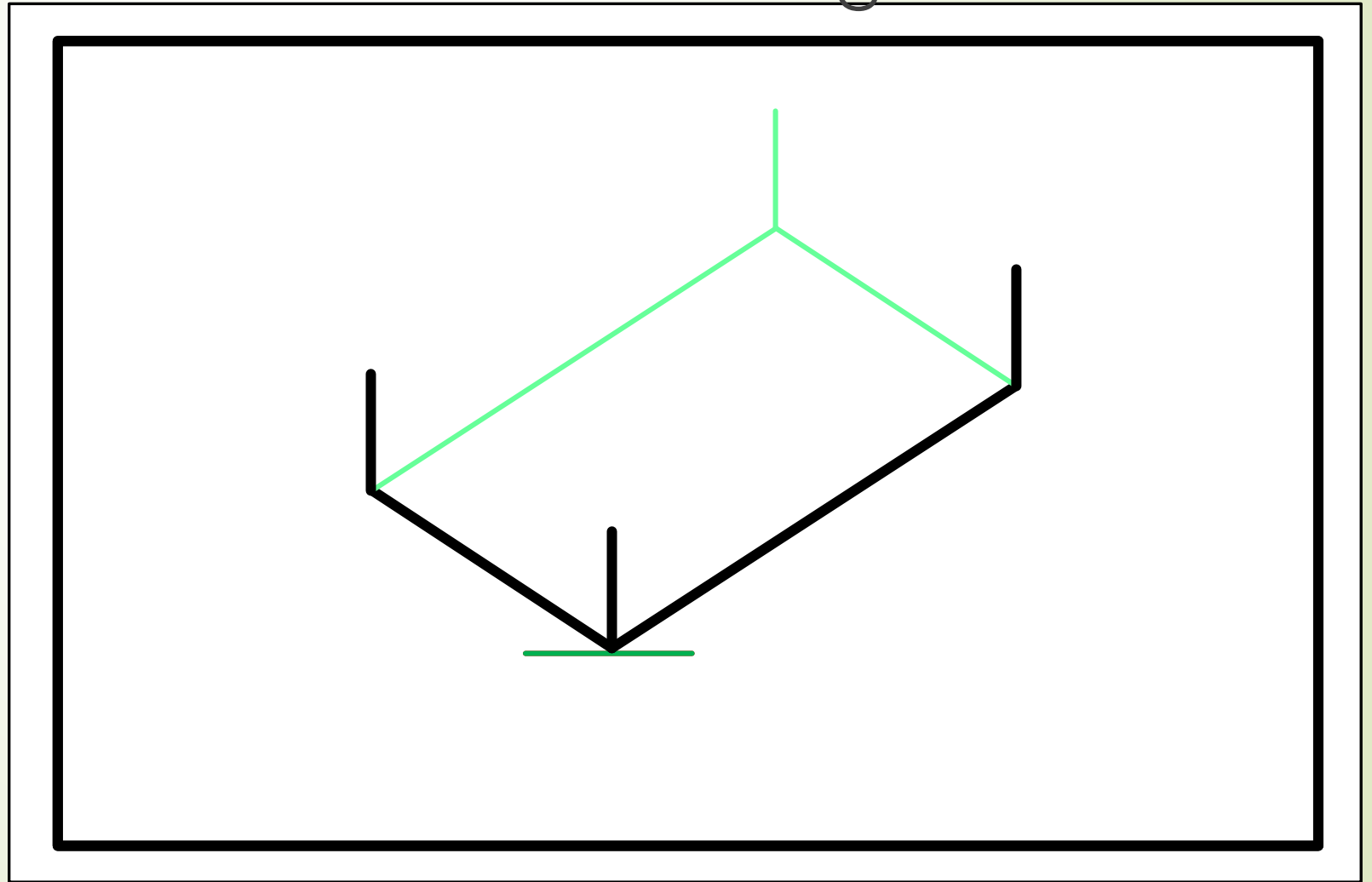
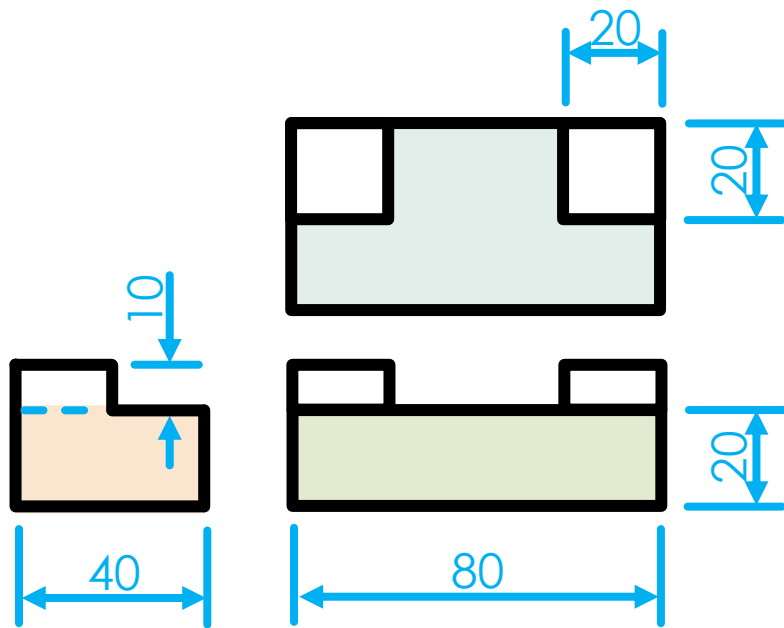

# ISOMETRIC DRAWINGS

- **Question:** Use the given orthographic views and convert it into an isometric drawing.

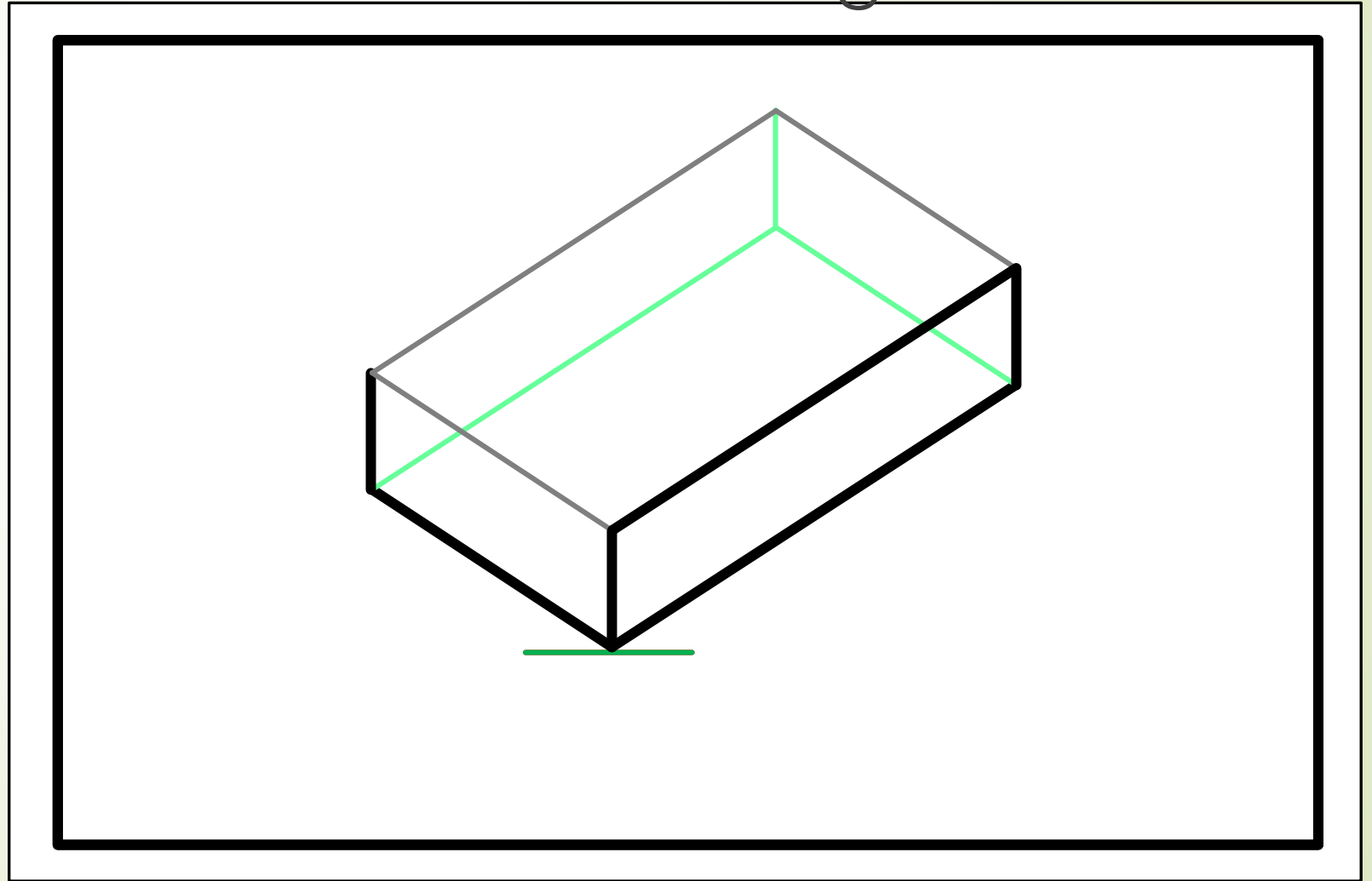
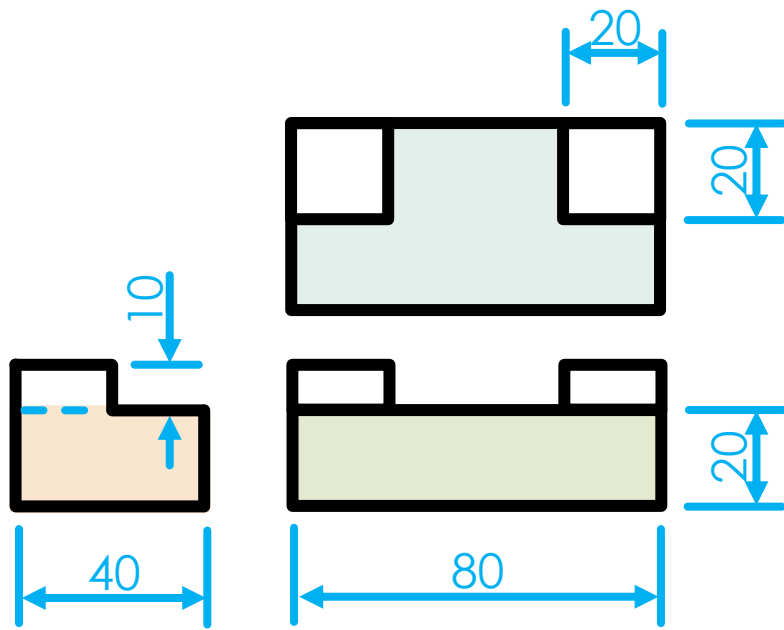

# ISOMETRIC DRAWINGS

- **Question:** Use the given orthographic views and convert it into an isometric drawing.

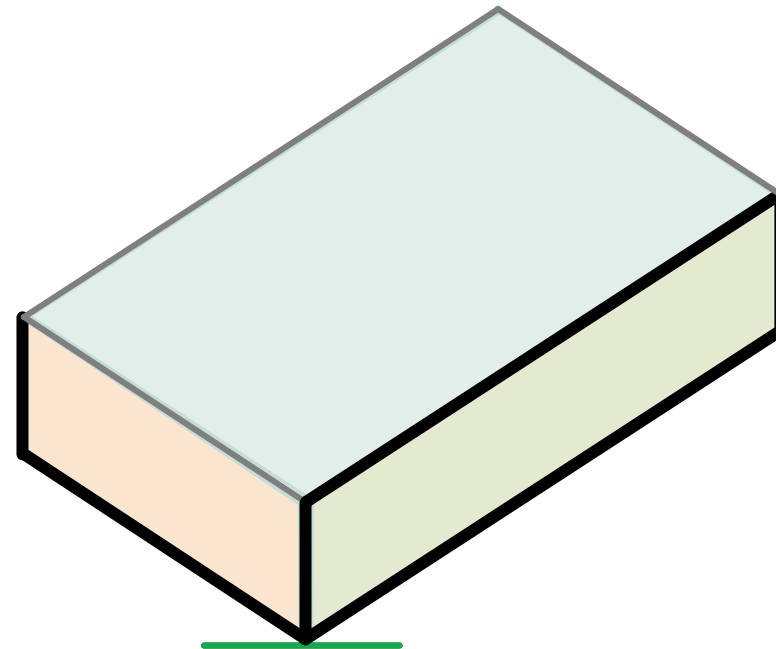
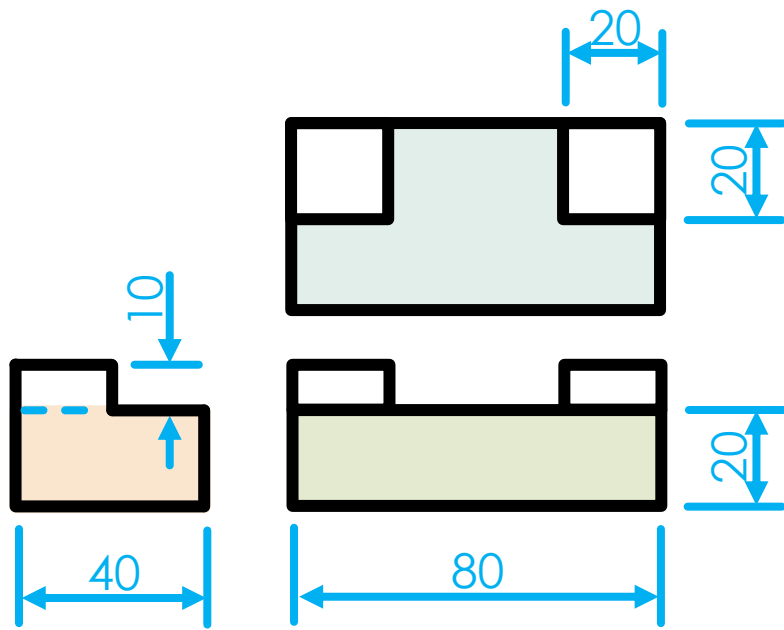

# ISOMETRIC DRAWINGS

- **Question:** Use the given orthographic views and convert it into an isometric drawing.

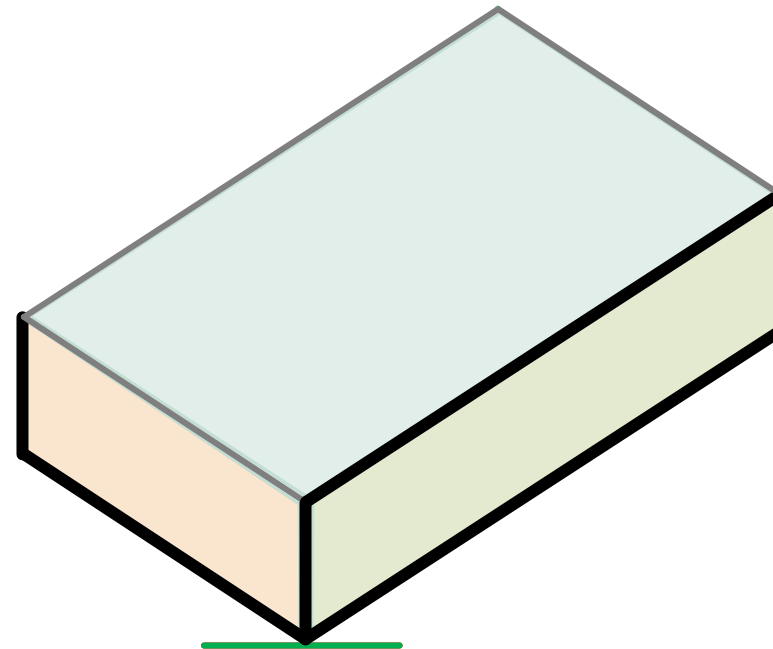
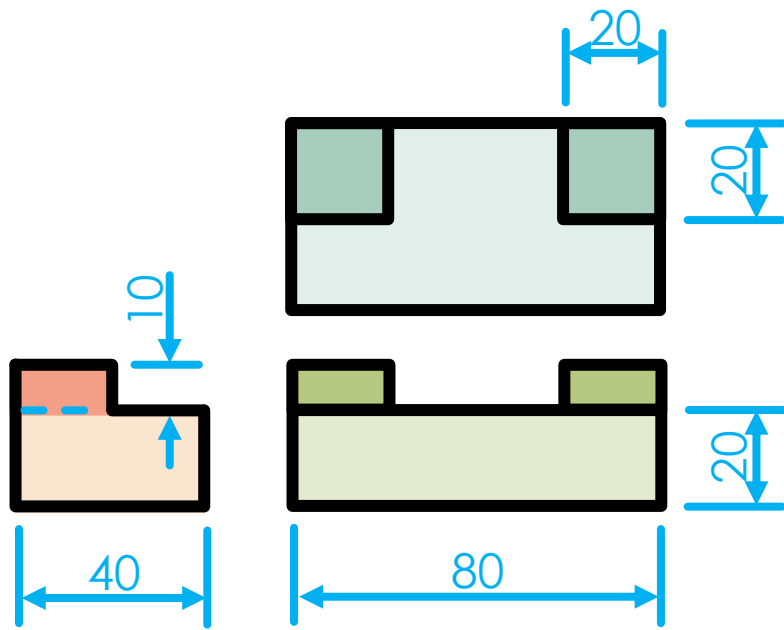



# ISOMETRIC DRAWINGS

- **Question:** Use the given orthographic views and convert it into an isometric drawing.

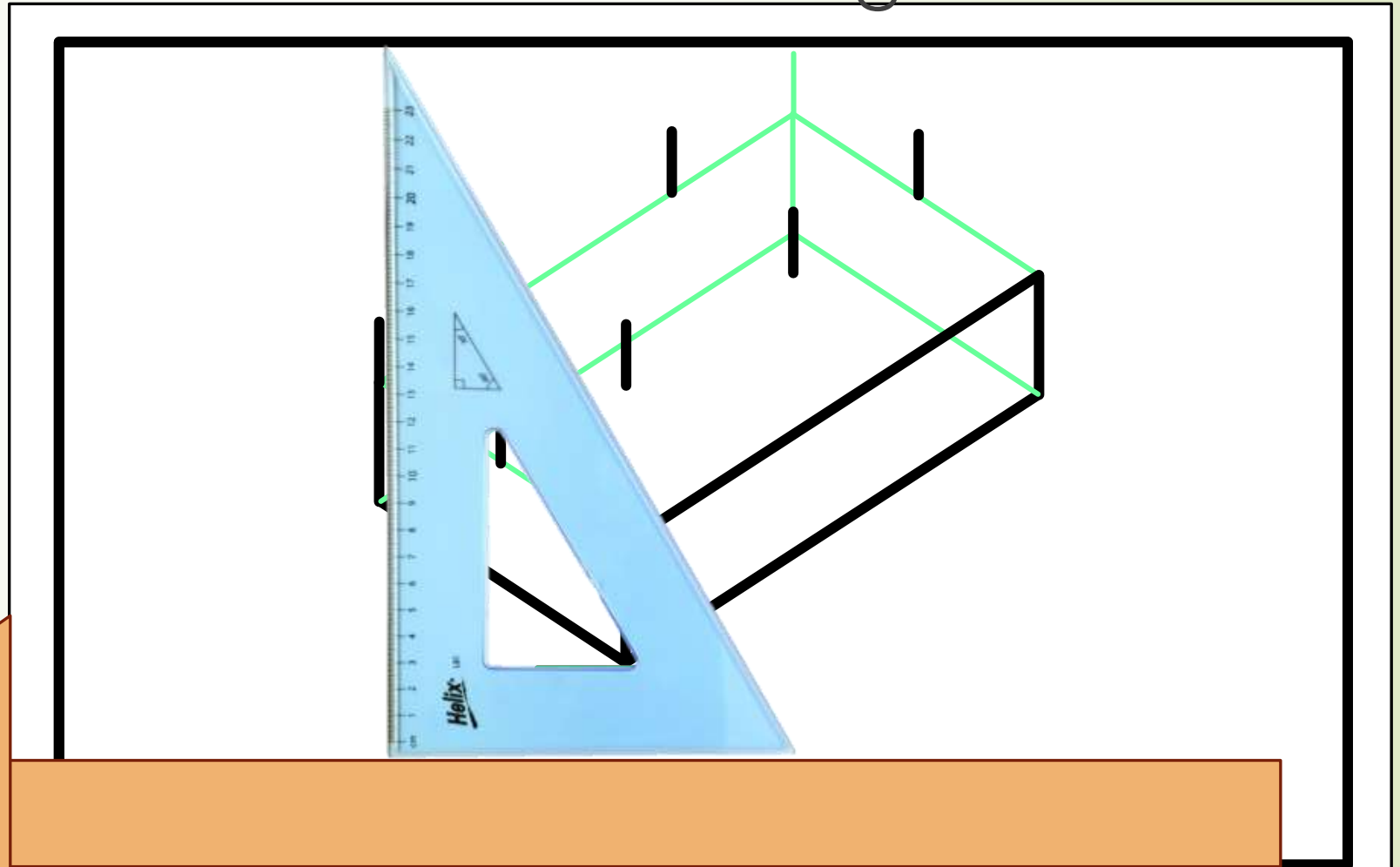
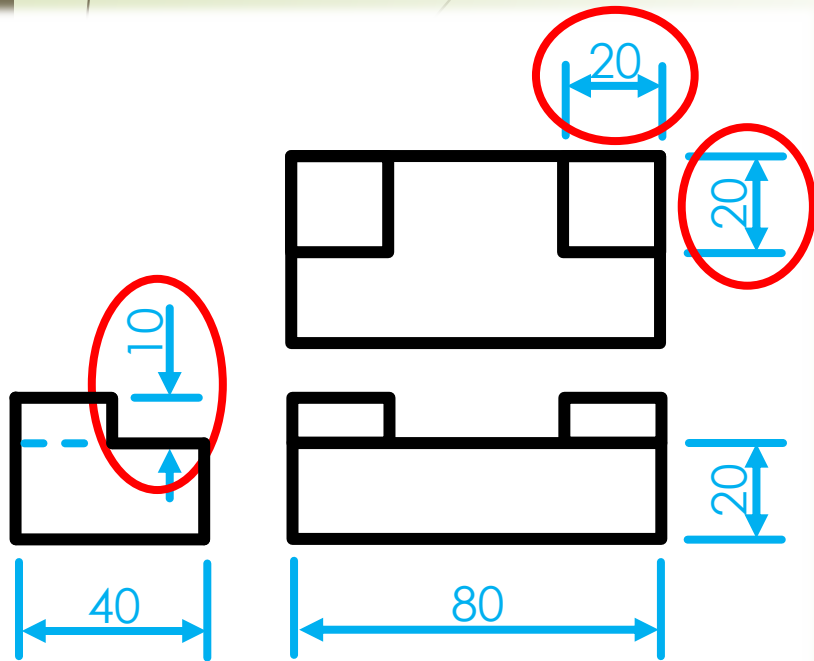

# ISOMETRIC DRAWINGS

- **Question:** Use the given orthographic views and convert it into an isometric drawing.

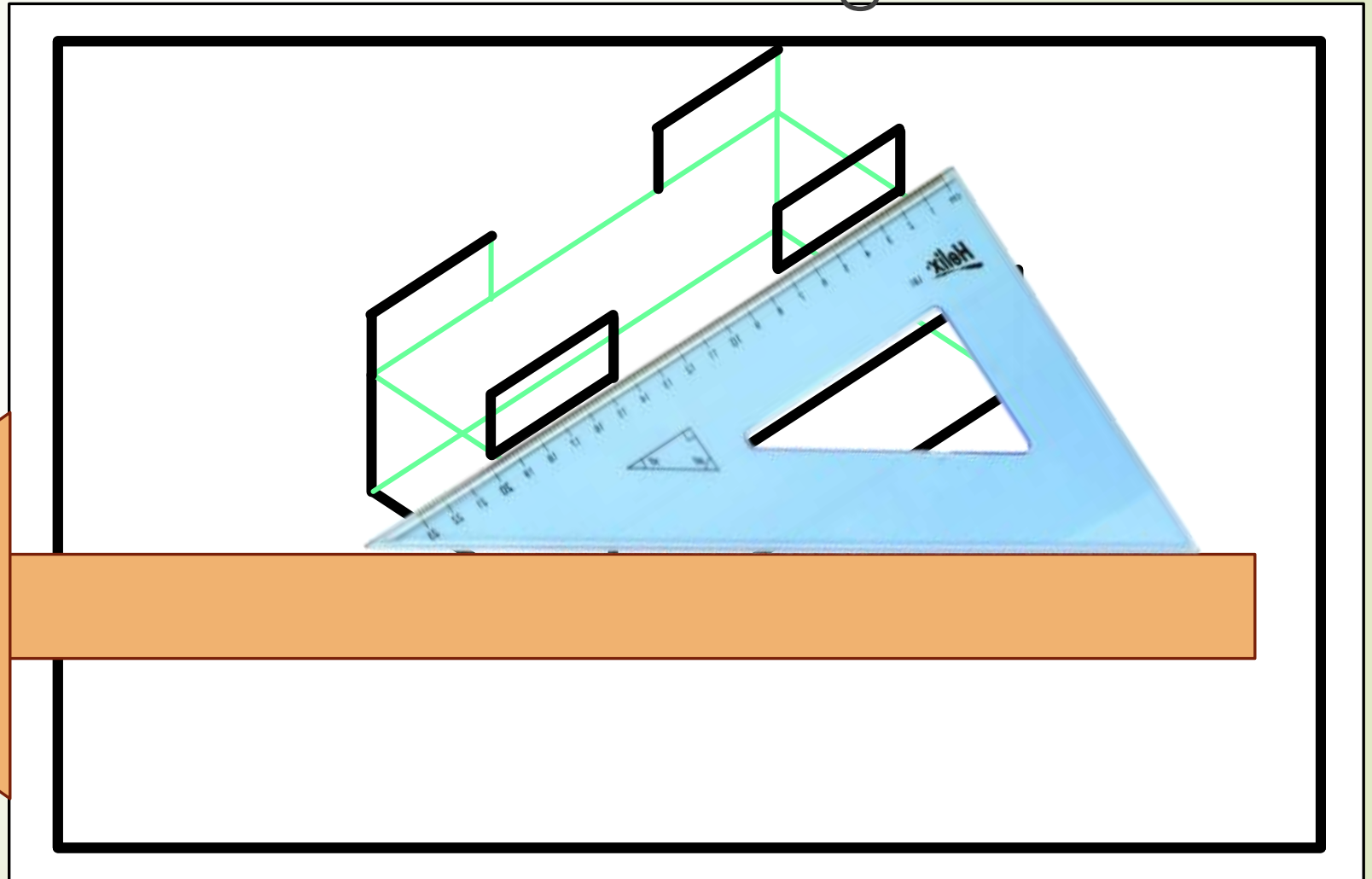
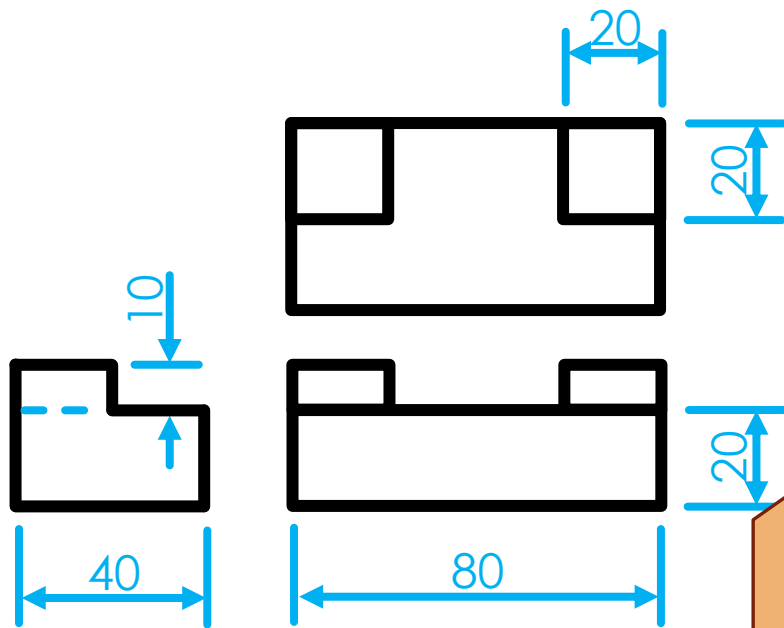

# ISOMETRIC DRAWINGS

- **Question:** Use the given orthographic views and convert it into an isometric drawing.

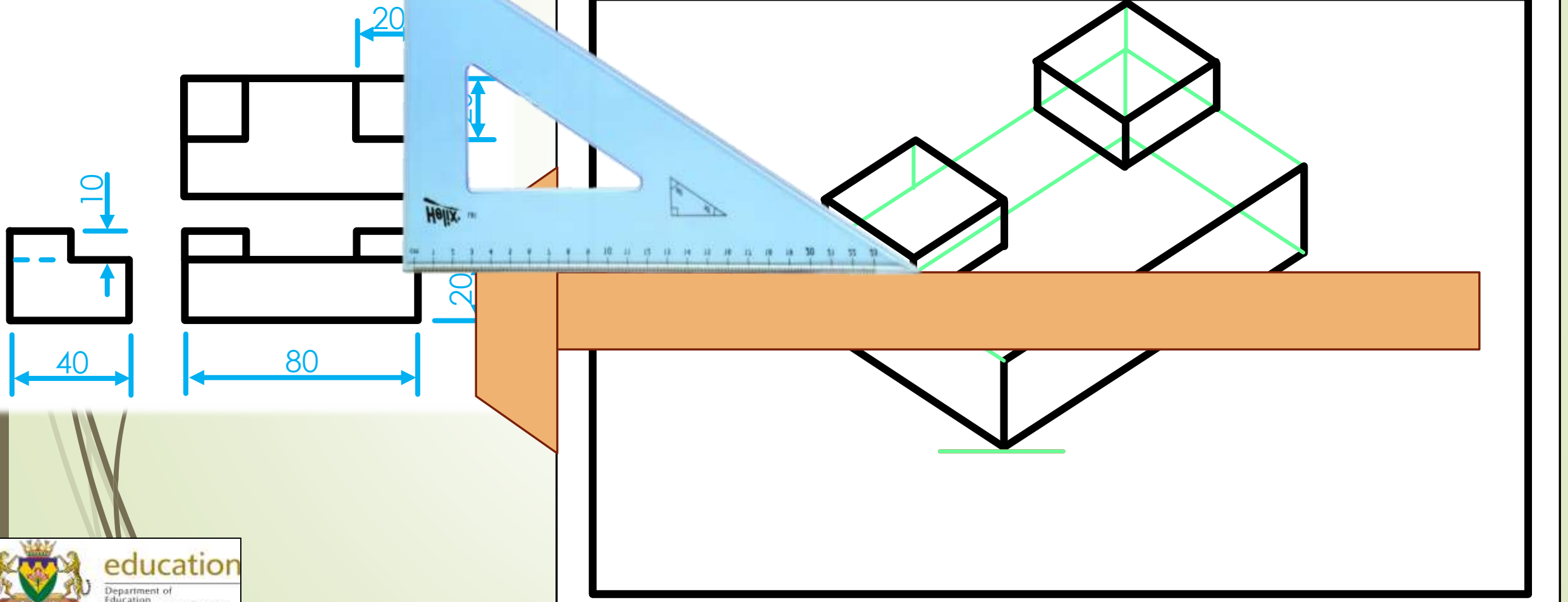

# ISOMETRIC DRAWINGS

- **Question:** Use the given orthographic views and convert it into an isometric drawing.

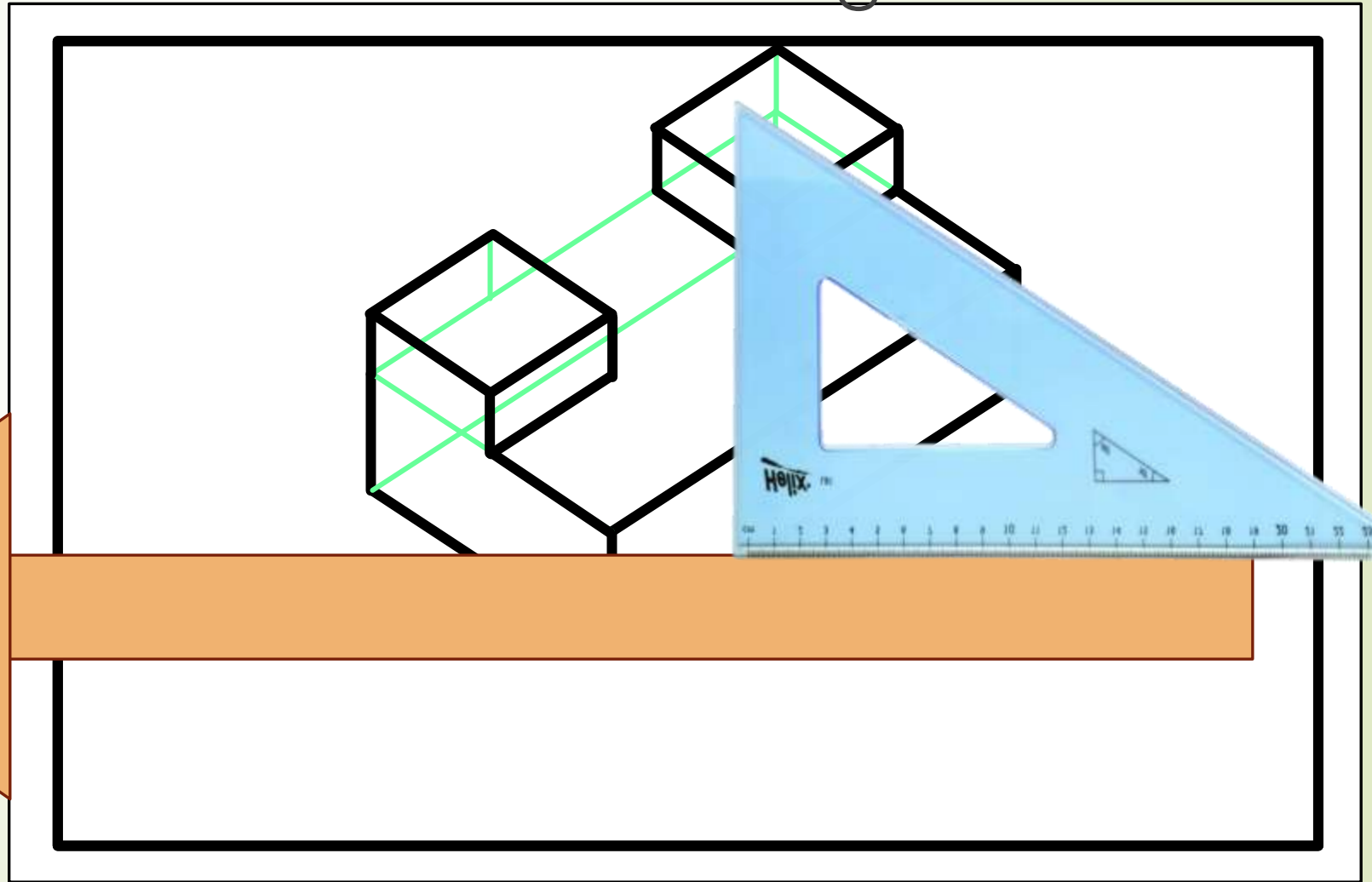
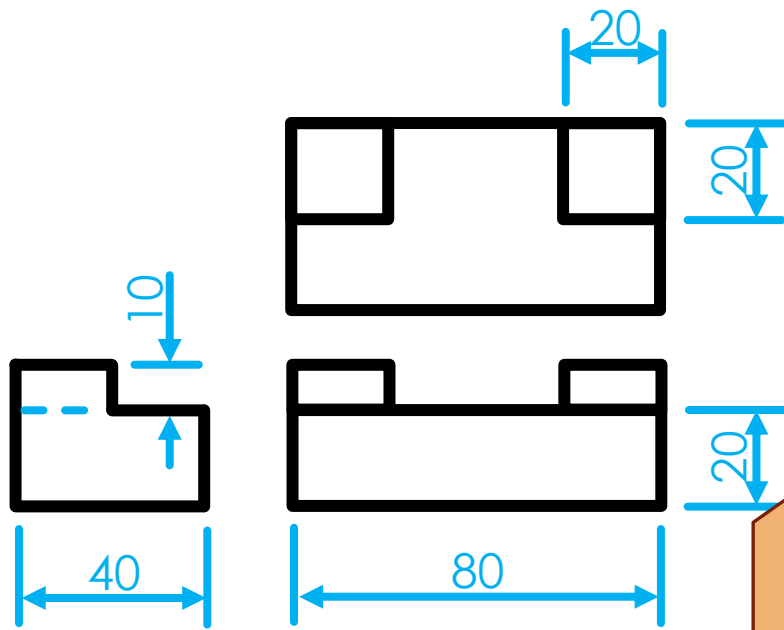

# ISOMETRIC DRAWINGS

- **Question:** Use the given orthographic views and convert it into an isometric drawing.

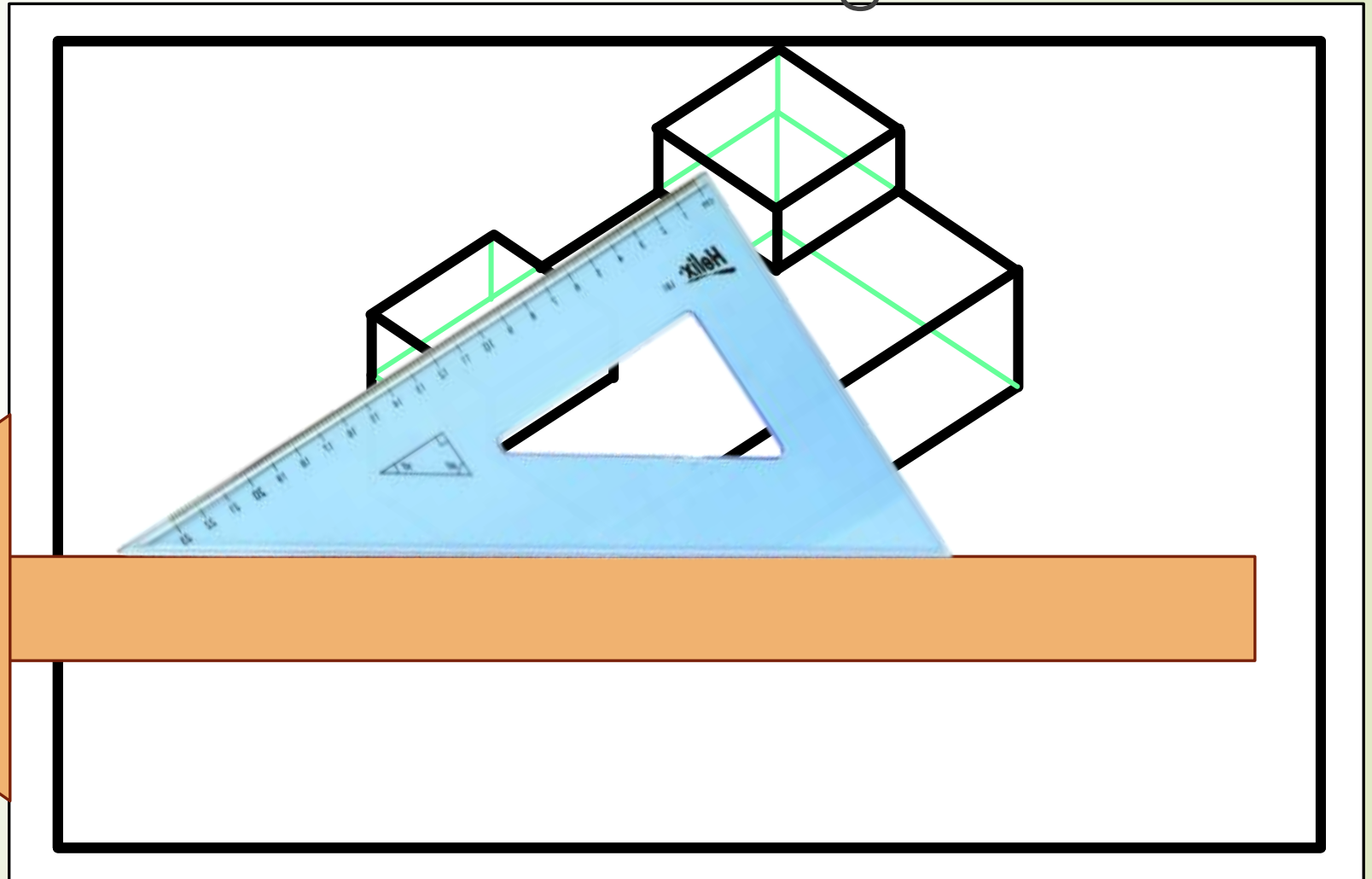
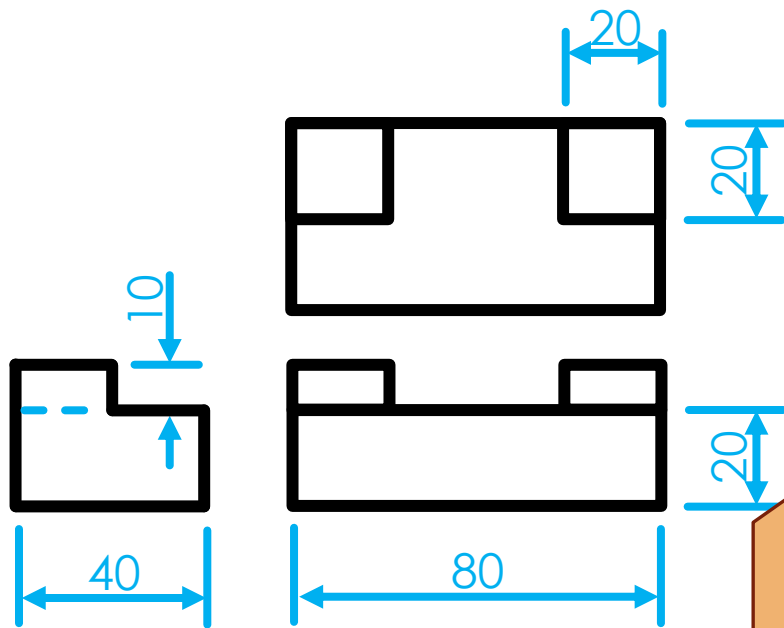

# ISOMETRIC DRAWINGS

- **Question:** Use the given orthographic views and convert it into an isometric drawing.

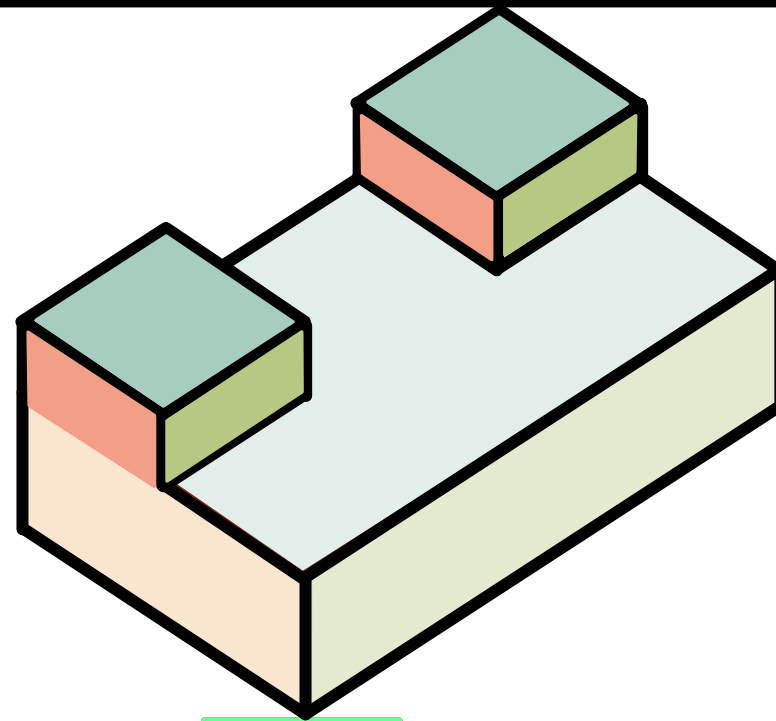
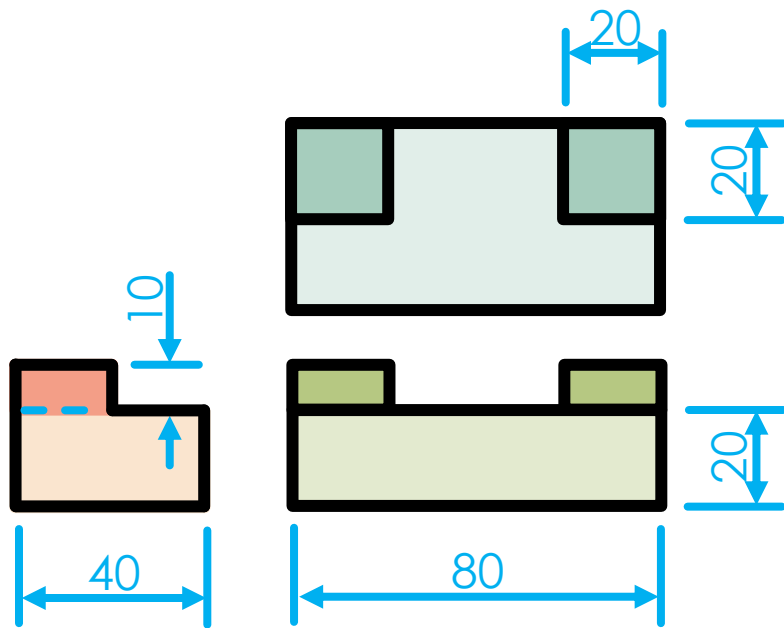

# ISOMETRIC DRAWINGS

- Start from the **bottom** and build the object to the **top**.

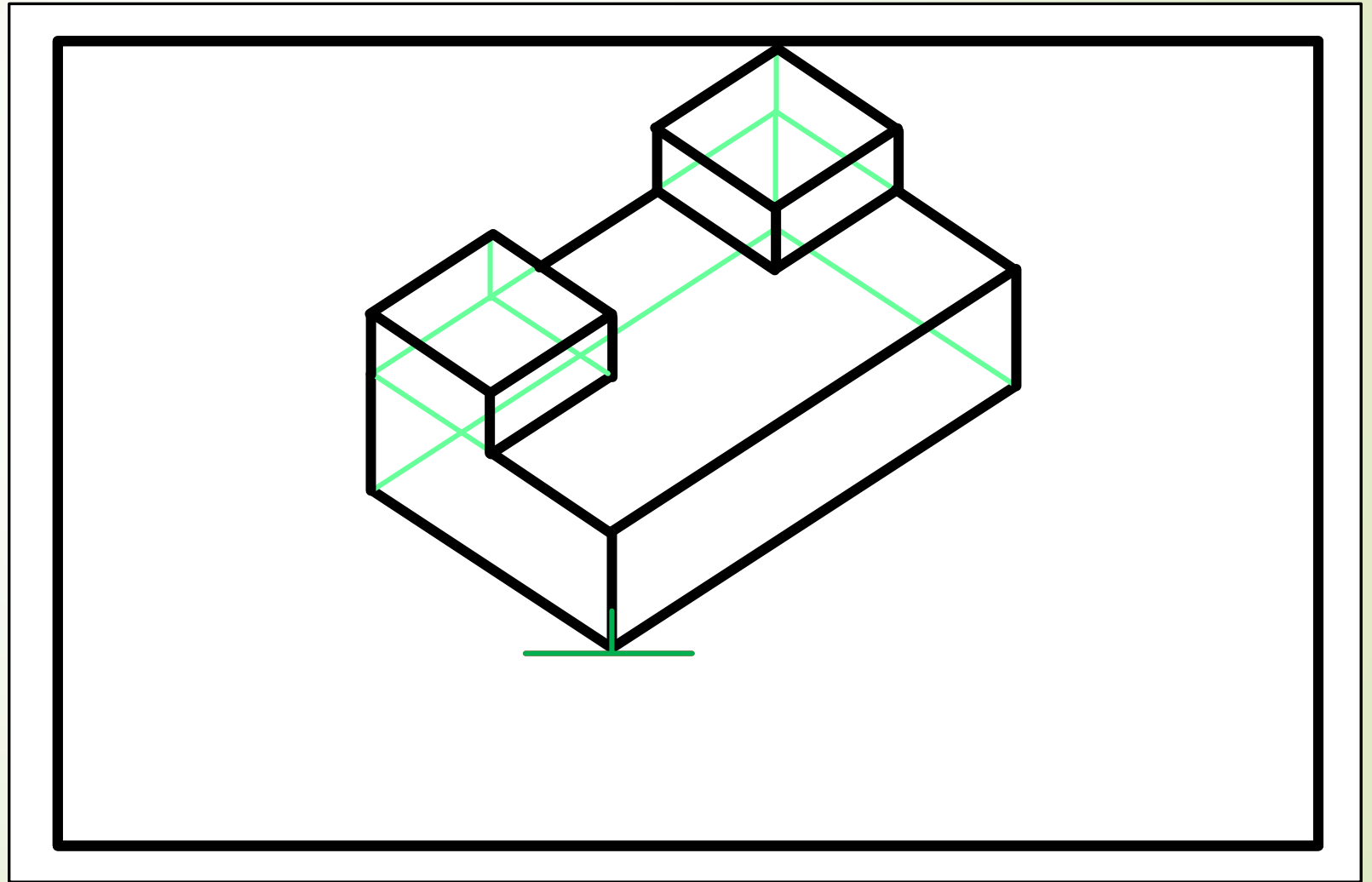
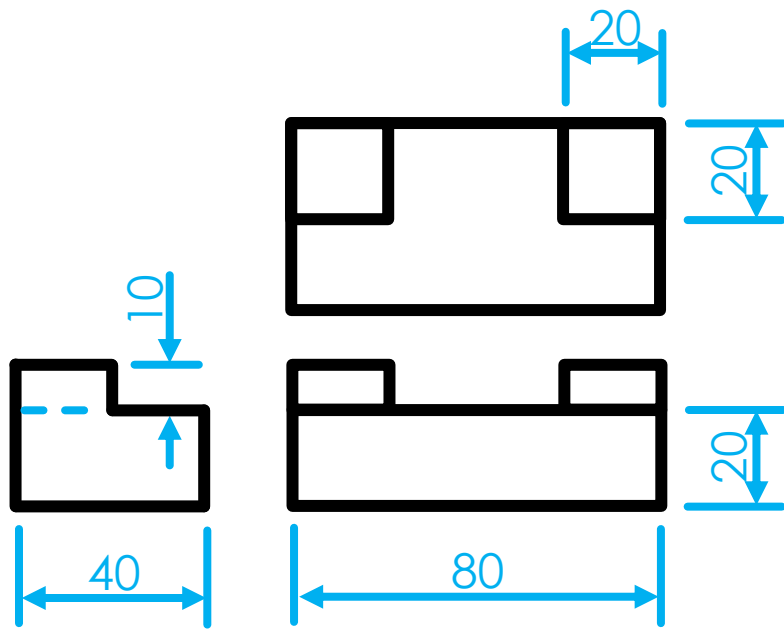

# ISOMETRIC DRAWINGS

- **Question:** Use the given orthographic views and convert it into an isometric drawing.

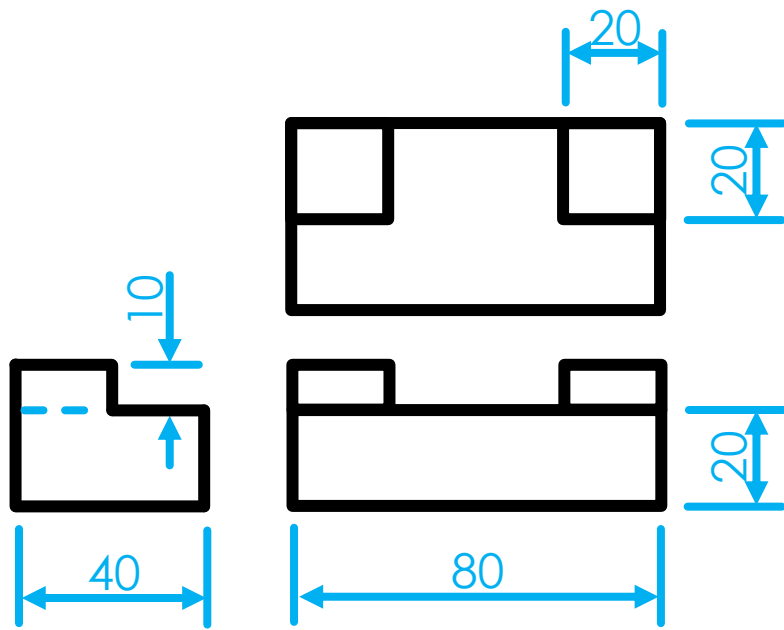

*If it is a casting  
you normally don't  
show a seam*

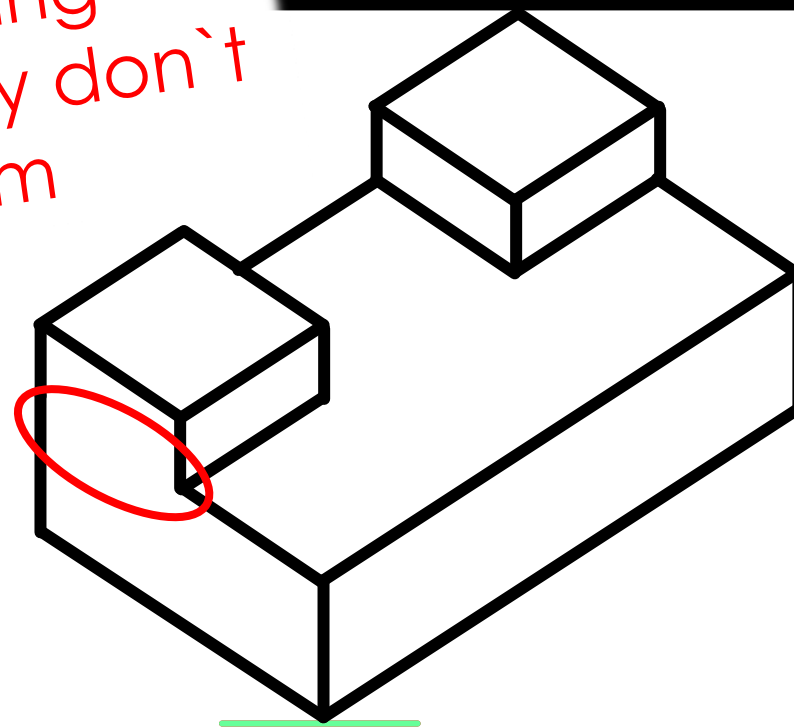



# ISOMETRIC DRAWINGS

- Show only hidden detail if required or when necessary for clarity.

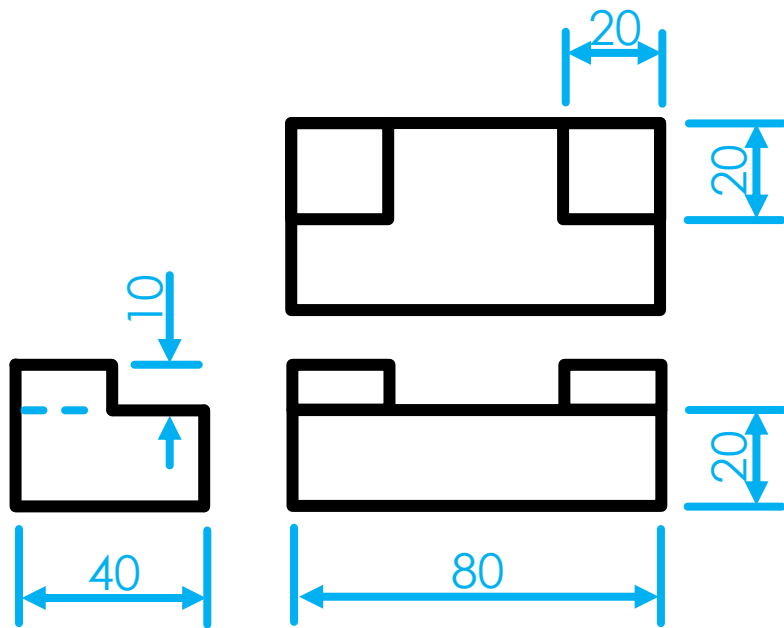

Should hidden detail be required

